

minimal system

vitco[®]
door & window system

BENEFITS



Sound Insulation

By installing Noise Cancellation Doors and Windows you can minimize noise pollution levels in your home by as much as a half.

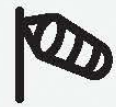

Wind Load

The Vitco aluminum windows and doors are stronger and has an extensive performance lifespan as compared to other window materials.



Water Tightness

Our aluminum windows and doors are made from innovative profiles to resist from Water, also come with no corrosion for lifetime feature.



Air Permeability

During these days buildings are very high-rise with glass outer finish, to hold such heavy glass of doors and windows our product comes with extensive capability.



Impact Resistance

Aluminum frames, doors and windows are very light in weight but very strong in comparison to wood and plastic, it has greater absorb capacity against unusual impacts.

INDEX

minimal system

V-14 SLIDING
WINDOW & DOOR 01

V-22 SLIDING
WINDOW & DOOR 07

V-28 SLIDING
WINDOW & DOOR 13

V-30 SLIDING
WINDOW & DOOR 19

V-38 SLIDING
WINDOW & DOOR 25

40MM HIGH-END
WINDOWS & DOOR 31

vitco[®]
door & window system

SC-85 CASEMENT
WINDOW 39

SC-3in1 CASEMENT
WINDOW 45

65MM THERMAL BREAK
WINDOW & DOOR 51

65MM THERMAL BREAK
MONORAIL DOOR 53



COLOUR
COLLECTION
55

V-14 SLIDING WINDOW & DOOR

minimal system



typologies

2 Track

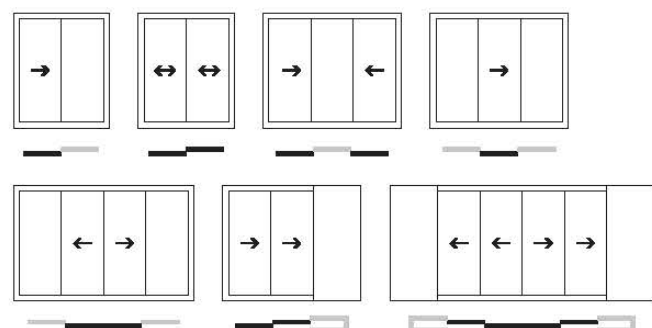

3 Track

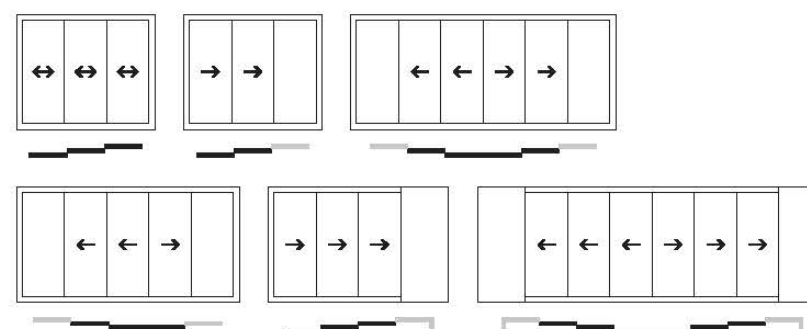



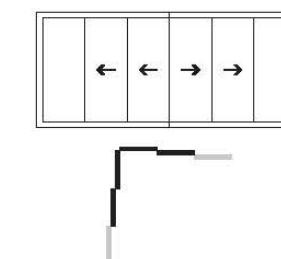

Open Corner



V-14
SLIDING
WINDOW
& DOOR

03

04

-  Sound Insulation
-  Wind Load
-  Air Permeability
-  Impact Resistance
-  Water Tightness

Door Height
Max. 2133mm

Sash
Height 2100mm
Width 1500mm

Glass Options
Single
Laminated

Glass Thickness
Min. 8mm
Max. 12mm

Sash Weight
Max 130 kg

Locking Variants
Up Down Lock

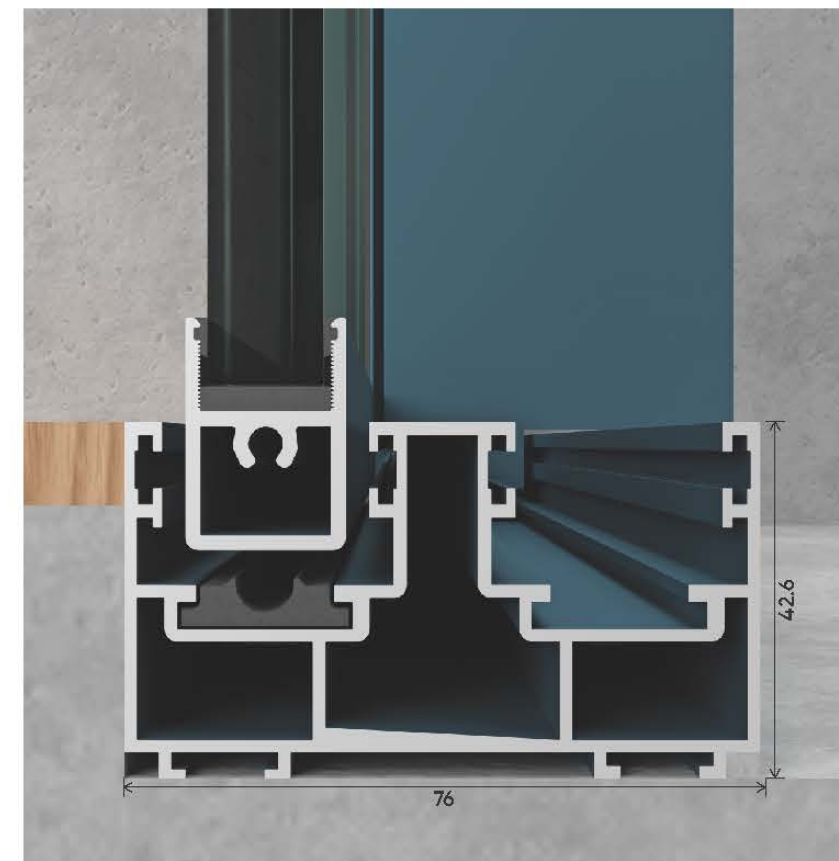
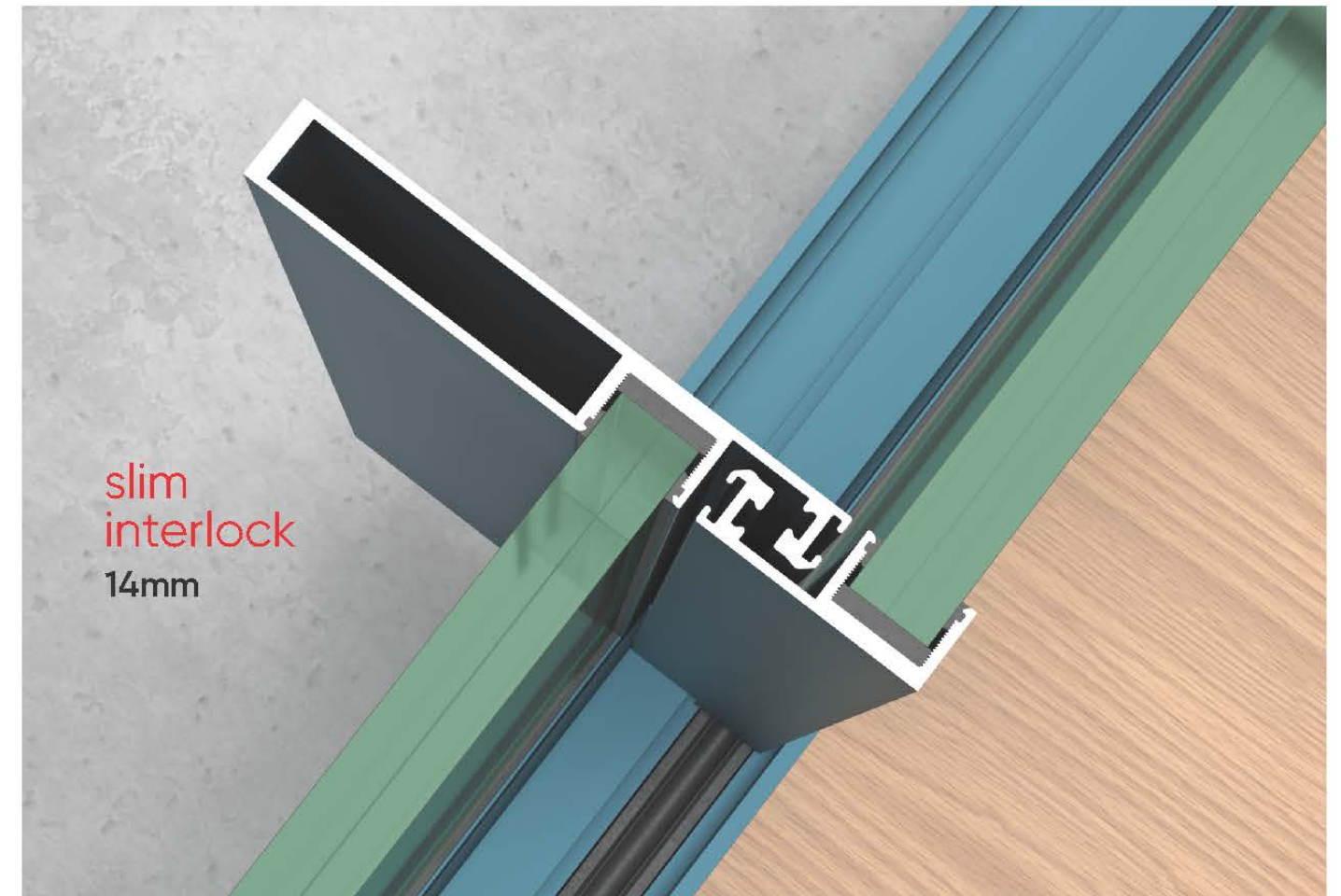

track
options
2 track
3 track

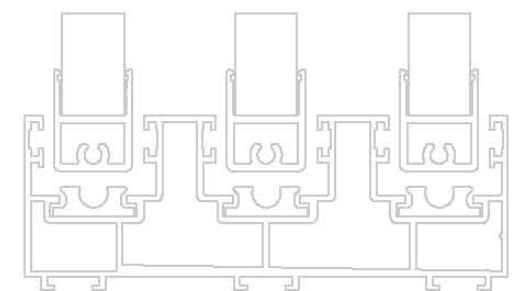

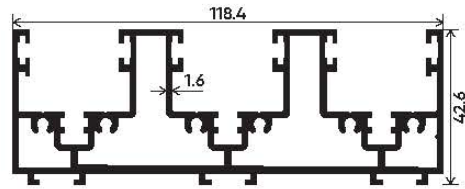

V-14-09

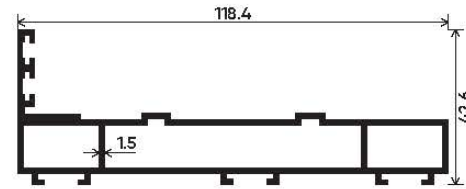

V-14-02

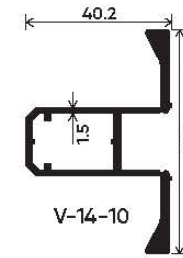

V-14-10

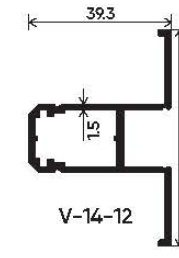

V-14-12

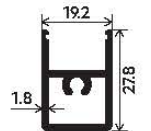

V-14-15

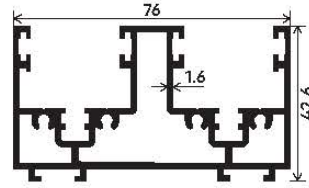

V-14-08

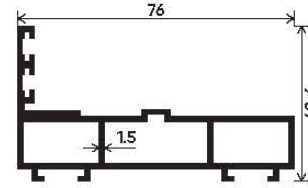

V-14-04

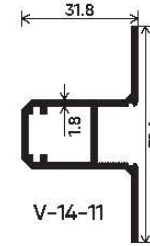

V-14-11

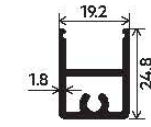

V-14-14

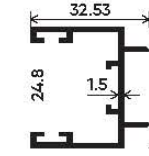

V-14-20

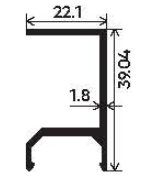

V-14-19

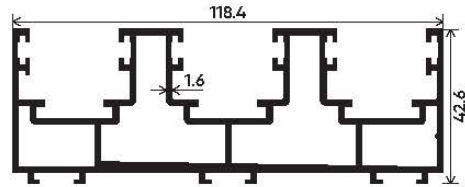

V-14-01

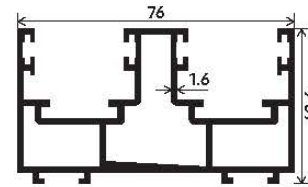

V-14-03

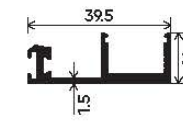

V-14-21

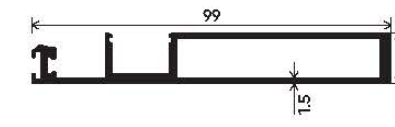

V-14-22

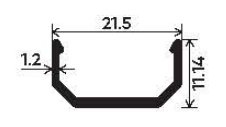

V-14-13

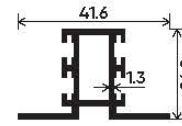
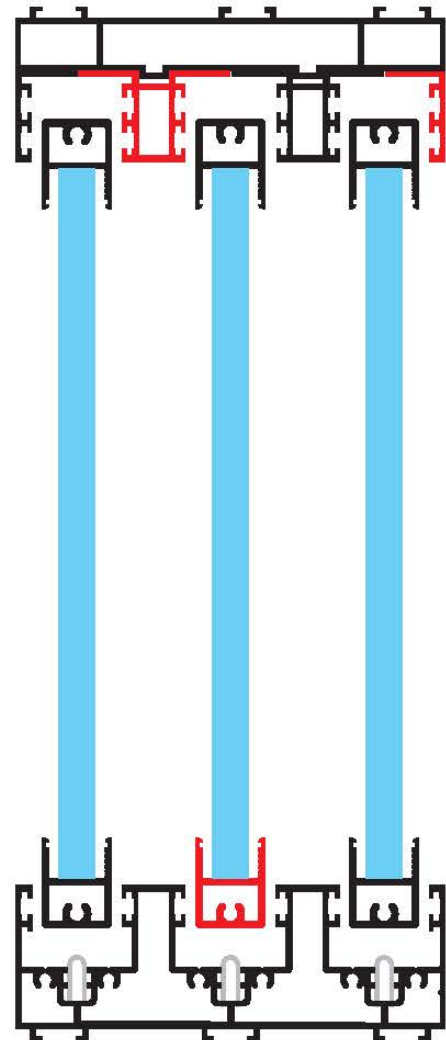

V-14-05

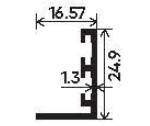

V-14-06

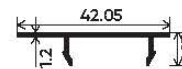

V-14-07

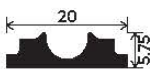

M-13

Section No.	Section Name	Weight (kg/mt)
V-14-09	Three Track Vertical & Bottom	2.575
V-14-02	Three Track Top	1.498
V-14-08	Two Track Vertical & Bottom	1.710
V-14-04	Two Track Top	1.192
V-14-01	Three Track Vertical & Bottom	2.450
V-14-03	Two Track Vertical & Bottom	1.671
V-14-05	Top Track Center Adapter	0.550
V-14-06	Top Track Inside Adapter	0.220
V-14-07	Track Cover	0.195
M-13	Bottom Rail Guide Adapter	0.231

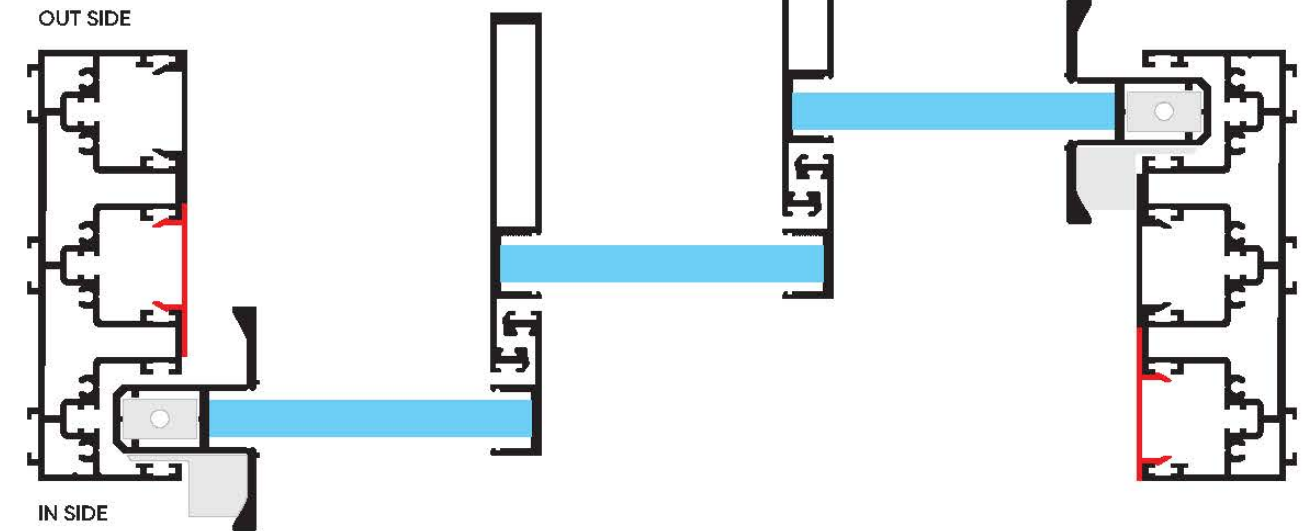

Section No.	Section Name	Weight (kg/mt)
V-14-10	Vertical Shutter Premium	0.882
V-14-12	Vertical Shutter	0.710
V-14-15	Top Bottom	0.518
V-14-11	Vertical Shutter	0.721
V-14-14	Top Bottom	0.478

Section No.	Section Name	Weight (kg/mt)
V-14-20	Center Opening Profile	0.410
V-14-19	Corner Opening	0.437
V-14-21	Slim Interlock	0.288
V-14-22	Reinforcement Interlock	0.993
V-14-13	Shutter Adapter	0.164



V-22 SLIDING
WINDOW & DOOR

minimal
system

The frameless sliding and fixed window system captivates by slim profile geometry and flush-fitted floors, ceiling and walls installation. It creates a seamless transition from inside to outdoors. The living spaces thus created enjoy maximum incidence of light.

V-22 SLIDING WINDOW & DOOR

09

10

vitco



-  Sound Insulation
-  Wind Load
-  Air Permeability
-  Impact Resistance
-  Water Tightness

Door Height
Max.
3048mm

Sash
Height 3000mm
Width 2000mm

Glass Options
Single - 8mm
Laminated - 11.5mm
DGU - 22mm

Sash Weight
Max 180 kgs
Locking Variants
Up Down Lock

track
options
2 track
3 track

slim
interlock
25mm

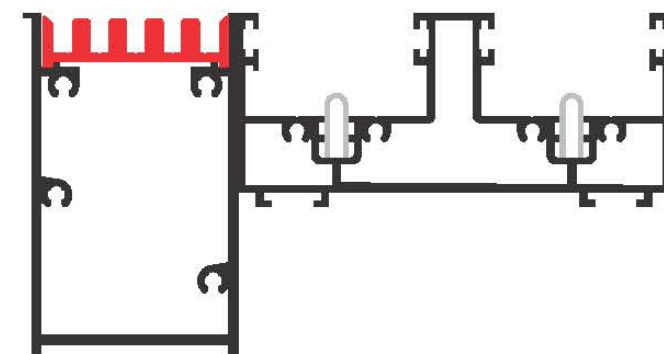

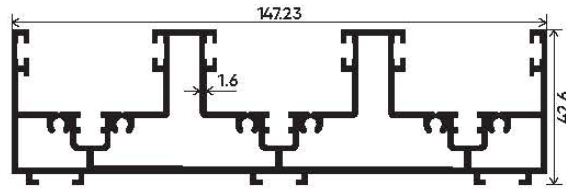

V-14-56

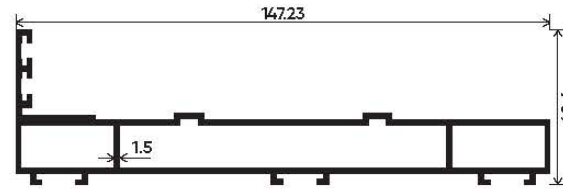

V-14-52

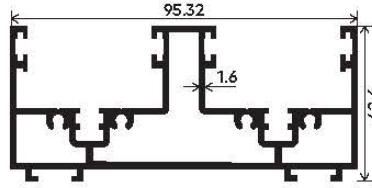

V-14-55

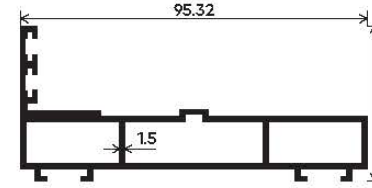

V-14-54

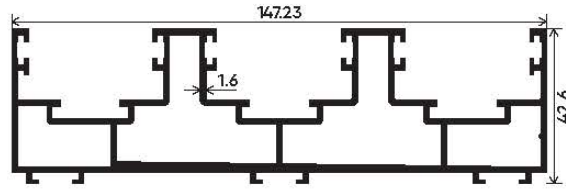

V-14-51

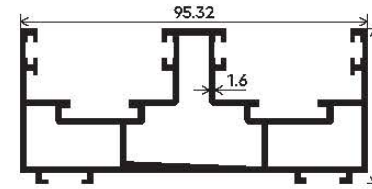

V-14-53

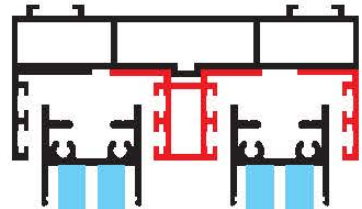

V-14-05

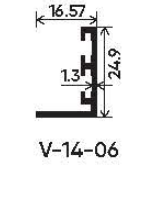

V-14-06

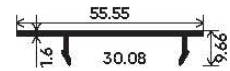

V-14-59

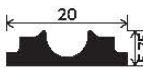

M-13

OUT SIDE IN SIDE

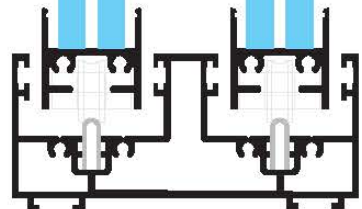

Section No.	Section Name	Weight (kg/mt)
V-14-56	Three Track Vertical & Bottom	2.790
V-14-52	Three Track Top	1.695
V-14-55	Two Track Vertical & Bottom	1.886
V-14-54	Two Track Top	1.229
V-14-51	Three Track Vertical & Bottom	2.584
V-14-53	Two Track Vertical & Bottom	1.666
V-14-05	Top Track Center Adapter	0.550
V-14-06	Top Track Inside Adapter	0.220
V-14-59	Track Cover	0.273
M-13	Bottom Rail Guide Adapter	0.231

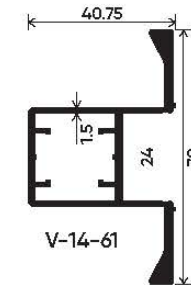

V-14-61

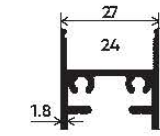

V-14-63

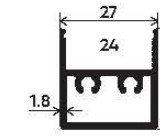

V-14-62

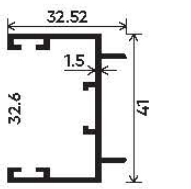

V-14-69

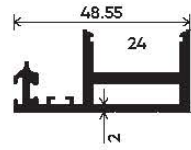

V-14-65

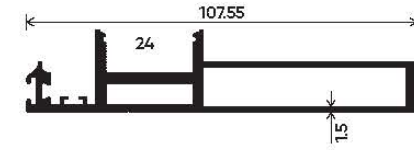

V-14-66

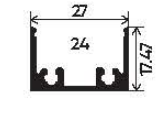

V-14-64

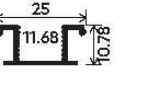

V-14-70

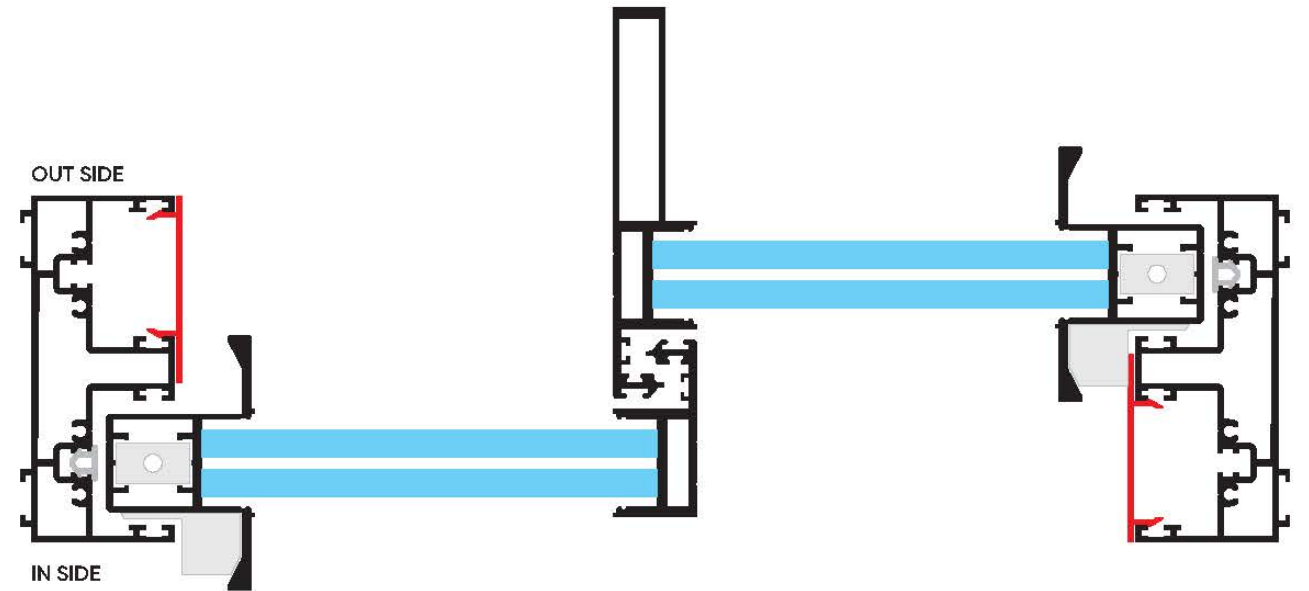

Section No.	Section Name	Weight (kg/mt)
V-14-61	Vertical Shutter Premium	1.000
V-14-63	Top Bottom	0.533
V-14-62	Top Bottom	0.541
V-14-69	Center Opening Profile	0.437

Section No.	Section Name	Weight (kg/mt)
V-14-65	Slim Interlock	0.847
V-14-66	Reinforcement Interlock	1.393
V-14-64	Top Shutter Profile	0.314
V-14-70	Glass Reduce Clip	0.163



V-28 SLIDING WINDOW & DOOR

minimal
system

Designed for those who appreciate aesthetics and functionality, our minimal window and door systems redefine luxury. With frames crafted from premium aluminum, they exude durability and style. Covering heights of up to 14 feet, they create a grand statement in any room. Perfect for spaces where design meets practicality.

V-28
SLIDING WINDOW
& DOOR

15

16

vitco

slim
interlock
25mm
31mm

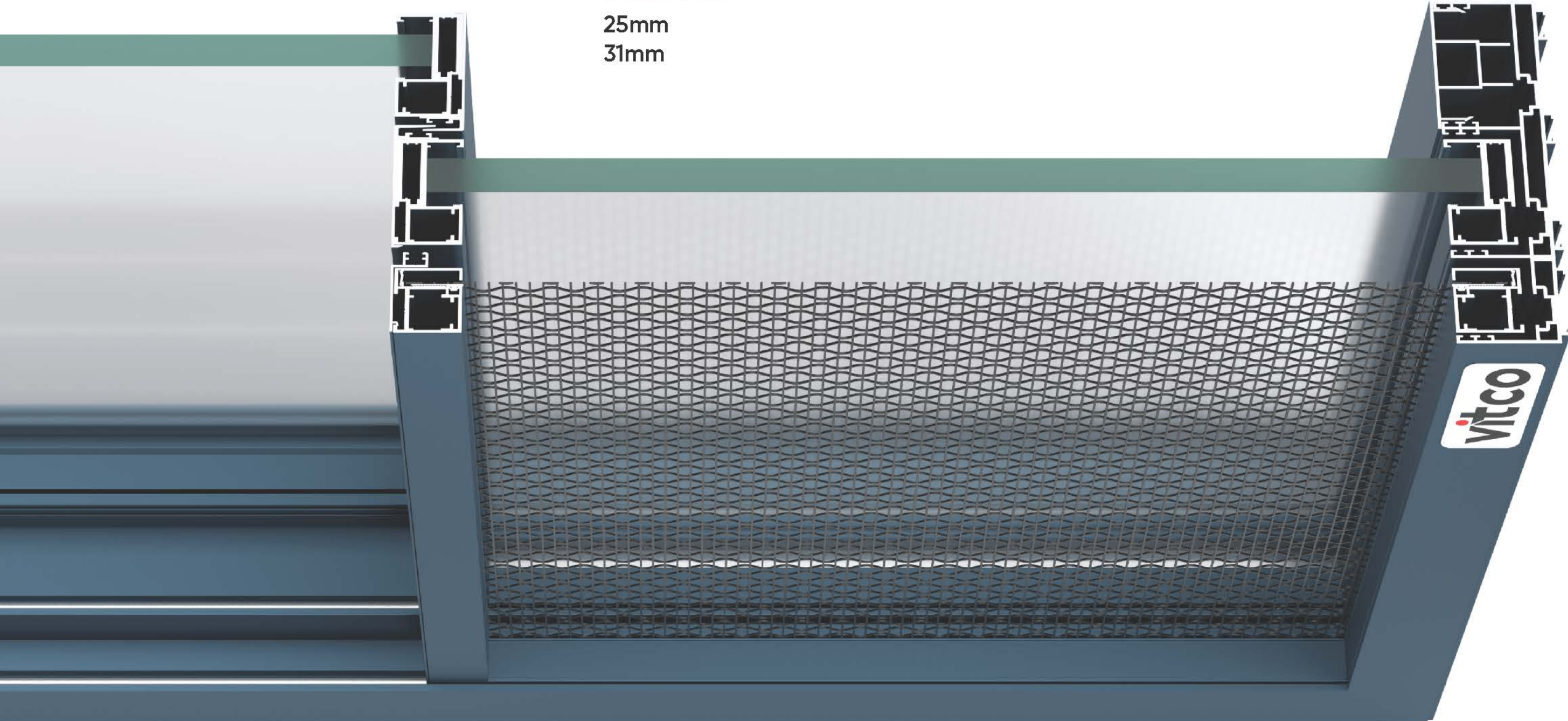

Height
Limit
Upto
14
Feet

Door Height
Max.
4268mm

Sash
Height **4200mm**
Width **2500mm**

Glass Options
Single - 8mm
Laminated - 11.5mm
DGU - 26mm

Locking Variants
Multipoint
Locking

Sash Weight
Max 260 kgs

2 Track

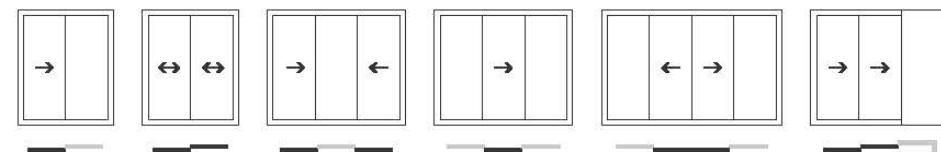

Typologies

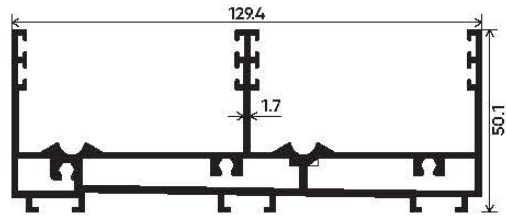

V-28-11

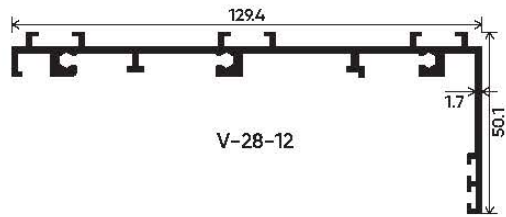

V-28-12

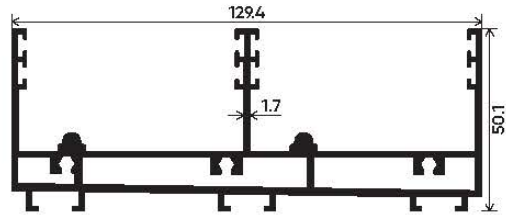

V-28-01

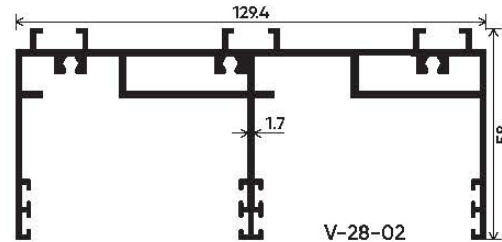

V-28-02

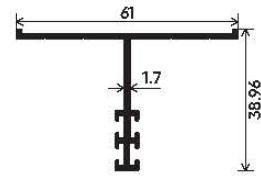

V-28-13

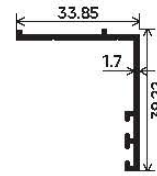

V-28-14

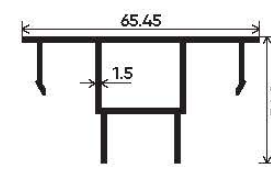

V-28-08

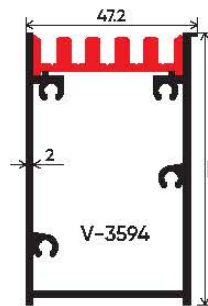

V-3594

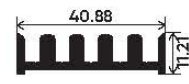

V-3595

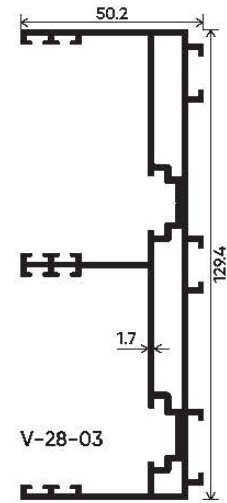

V-28-03

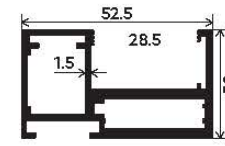

V-28-04

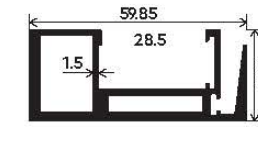

V-28-07

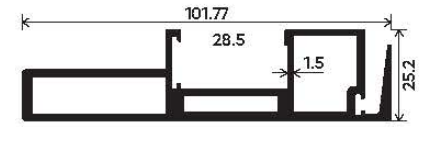

V-28-06

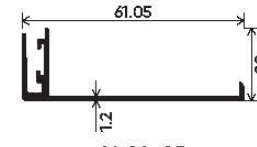

V-28-05

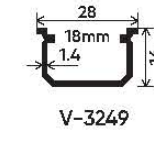

V-3249

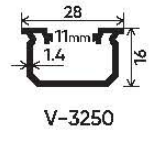

V-3250

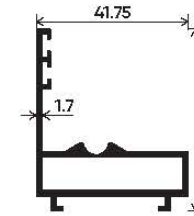

V-28-21

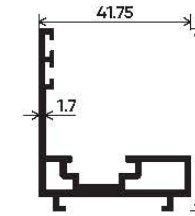

V-28-25

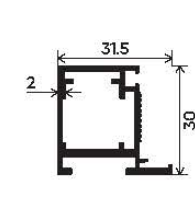

V-28-22

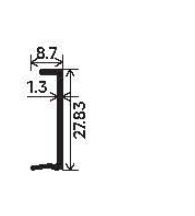

V-28-23

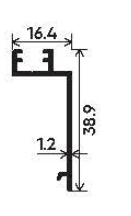

V-28-24

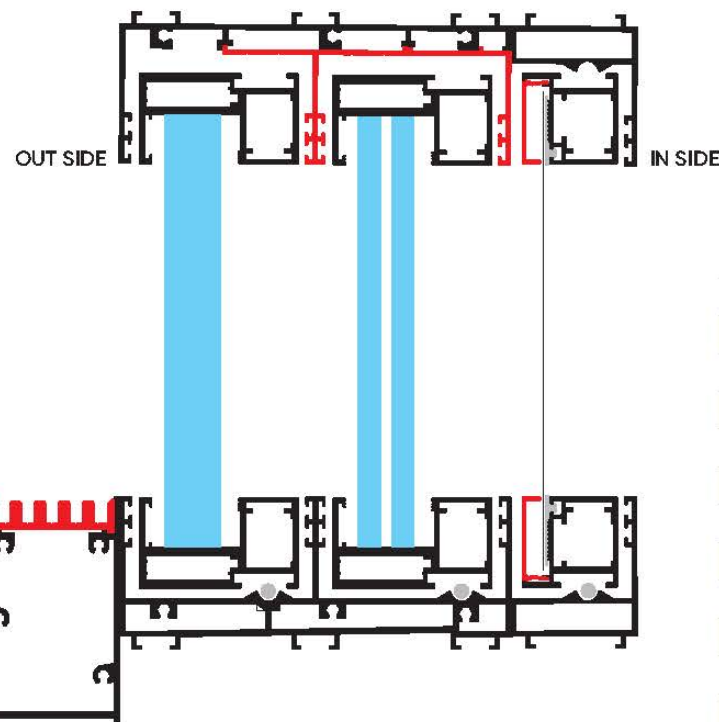

Section No.	Section Name	Weight (kg/mt)
V-28-11	Two Track Bottom	2.460
V-28-12	Two Track Top	1.360
V-28-03	Two Track Vertical	2.035
V-28-01	Two Track Bottom	2.460
V-28-02	Two Track Top	2.385
V-28-13	Top Track Adapter	0.550
V-28-14	Top Track Adapter	0.344
V-28-08	Track Cover	0.710
V-3594	Invisible Drainage	1.336
V-3595	Drainage Cover	0.620

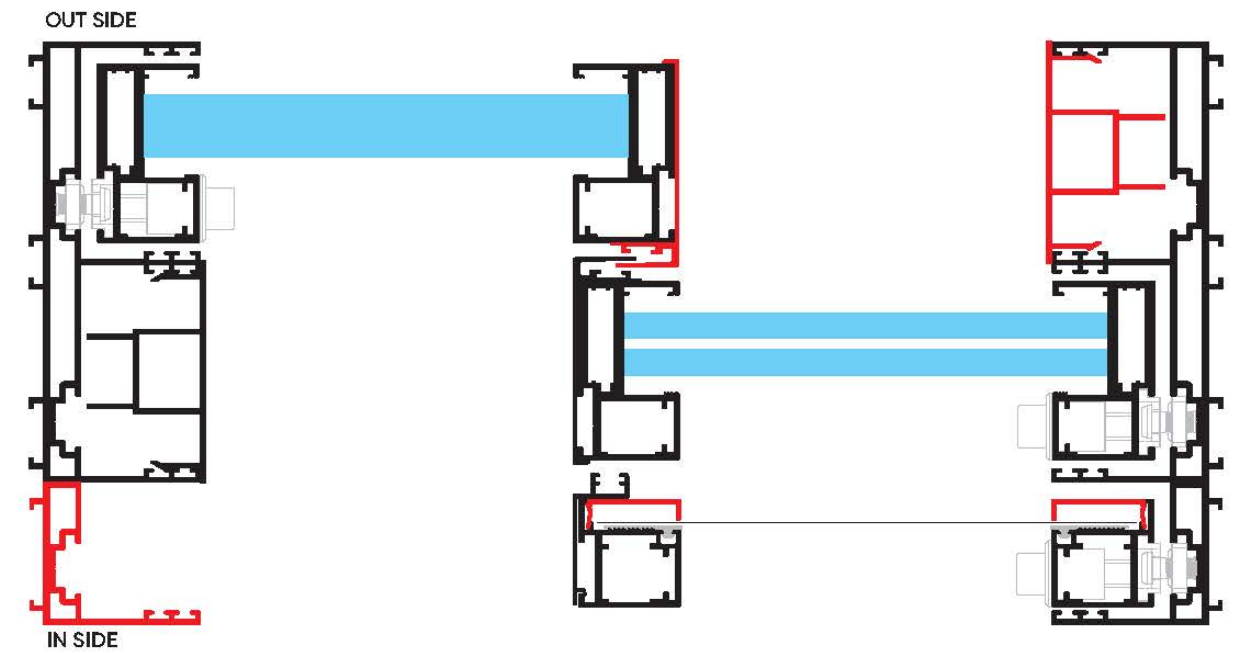

Section No.	Section Name	Weight (kg/mt)
V-28-04	Shutter Profile	1.117
V-28-07	Slim Interlock	1.155
V-28-06	Reinforcement Interlock	2.622
V-28-05	Universal Interlock	0.349
V-3249	Laminated Reducer Clip	0.221
V-3250	SGU Reducer Clip	0.262

Section No.	Section Name	Weight (kg/mt)
V-28-21	Additional Top Bottom	0.720
V-28-25	Additional Vertical	0.760
V-28-22	Mosquito Shutter	0.545
V-28-23	Mosquito Shutter Clip	0.132
V-28-24	Mosquito Shutter Interlock	0.216



V-30 SLIDING WINDOW & DOOR

minimal
system

Experience the elegance of minimal windows and doors designed for modern living. Crafted with precision, these systems offer seamless integration into your space, making them perfect for bedrooms, living rooms, and balconies. Superior quality aluminum ensures durability while maintaining a sleek, sophisticated appearance. Let natural light flow in while enjoying unparalleled views.

V-30
SLIDING
WINDOW
& DOOR

21



-  Sound Insulation
-  Wind Load
-  Air Permeability
-  Impact Resistance
-  Water Tightness

Door Height
Max.
3660mm

Sash
Height **3600mm**
Width **2500mm**

Glass Options
Single - 8mm
Laminated - 11.5mm
DGU - 28mm

Sash Weight
Max 350 kg

Locking Variants
Up Down Lock

22

vitco V-30 SLIDING WINDOW & DOOR



2 Track

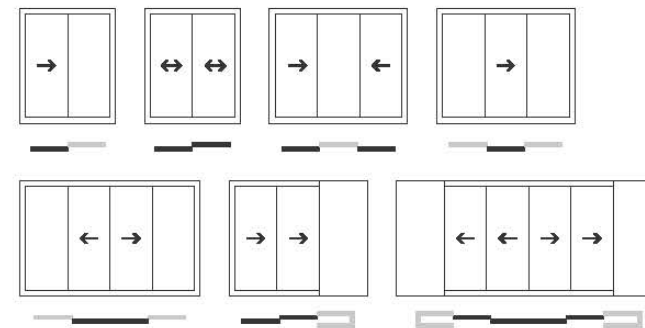

3 Track

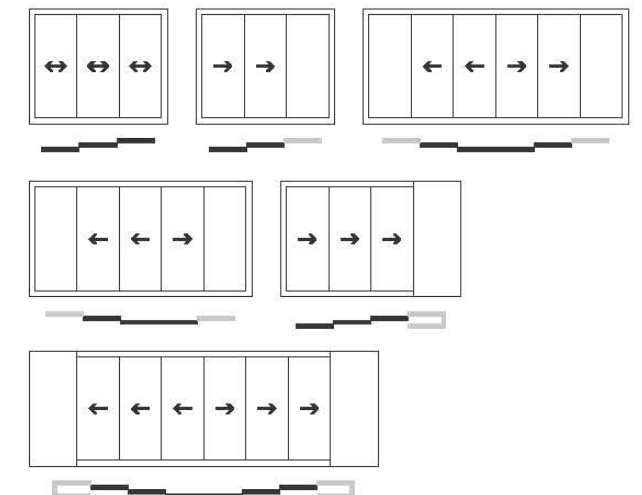

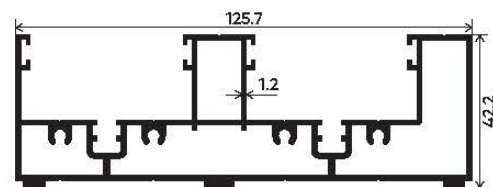

V-28-51

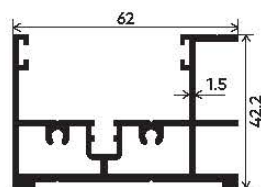

V-28-52

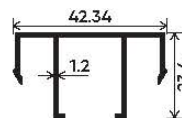

V-28-56

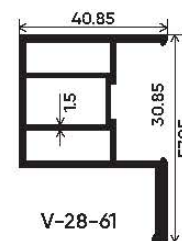

V-28-61

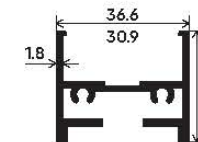

V-28-62

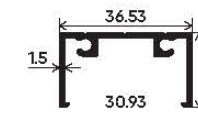

V-28-63

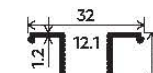

V-28-67

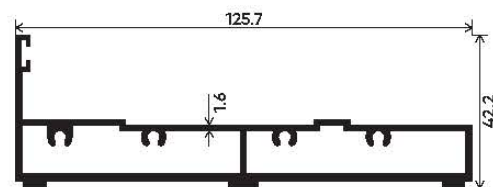

V-28-53

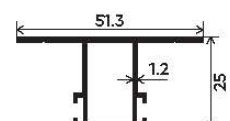

V-28-54

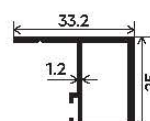

V-28-55



V-28-65

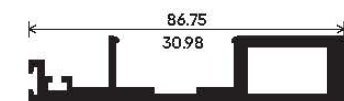

V-28-66

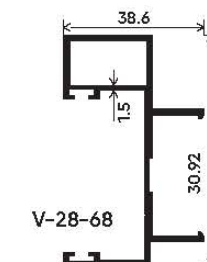

V-28-68

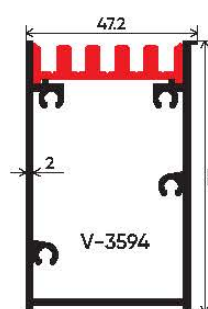
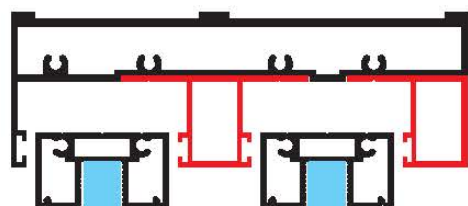
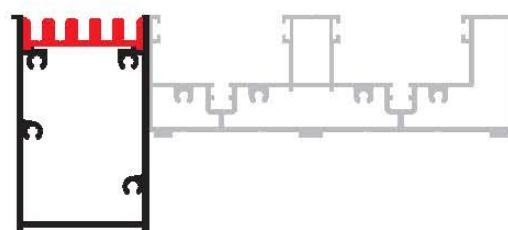
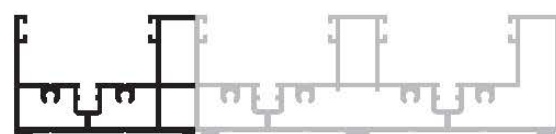

V-3594



V-3595

OUT SIDE IN SIDE

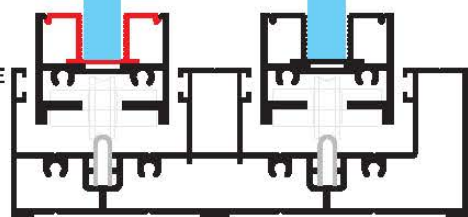

Section No.	Section Name	Weight (kg/mt)
V-28-51	Two Track Vertical & Bottom	2.186
V-28-52	Addon Track	-
V-28-56	Track Cover	0.369
V-28-53	Two Track Top	1.822
V-28-54	Top Track Center Adapter	0.424
V-28-55	Top Track Inside Adapter	0.366
V-3594	Invisible Drainage	1.336
V-3595	Drainage Cover	0.620

OUT SIDE

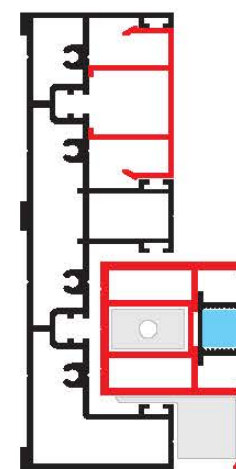

IN SIDE

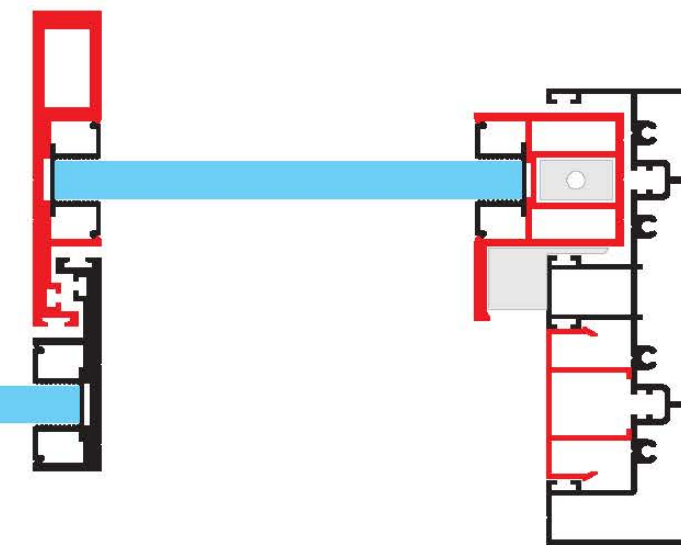

Section No.	Section Name	Weight (kg/mt)
V-28-61	Shutter Profile	1.126
V-28-62	Top Bottom Profile	0.710
V-28-63	Top Profile	0.389
V-28-67	Laminated Reducer Clip	0.240

Section No.	Section Name	Weight (kg/mt)
V-28-65	Slim Interlock	0.915
V-28-66	Reinforcement Interlock	1.571
V-28-68	Center Opening	0.821



V-38 SLIDING WINDOW & DOOR

minimal
system

Our minimal windows and doors combine superior craftsmanship with minimalist design. The slim frames maximize the glass area, allowing expansive views and abundant light. Ideal for bedrooms, living spaces, or balconies, they elevate the ambiance of any interior. Built with care, these systems ensure a timeless, modern look.

V-38
SLIDING
WINDOW
& DOOR

27

28

slim
interlock
16mm

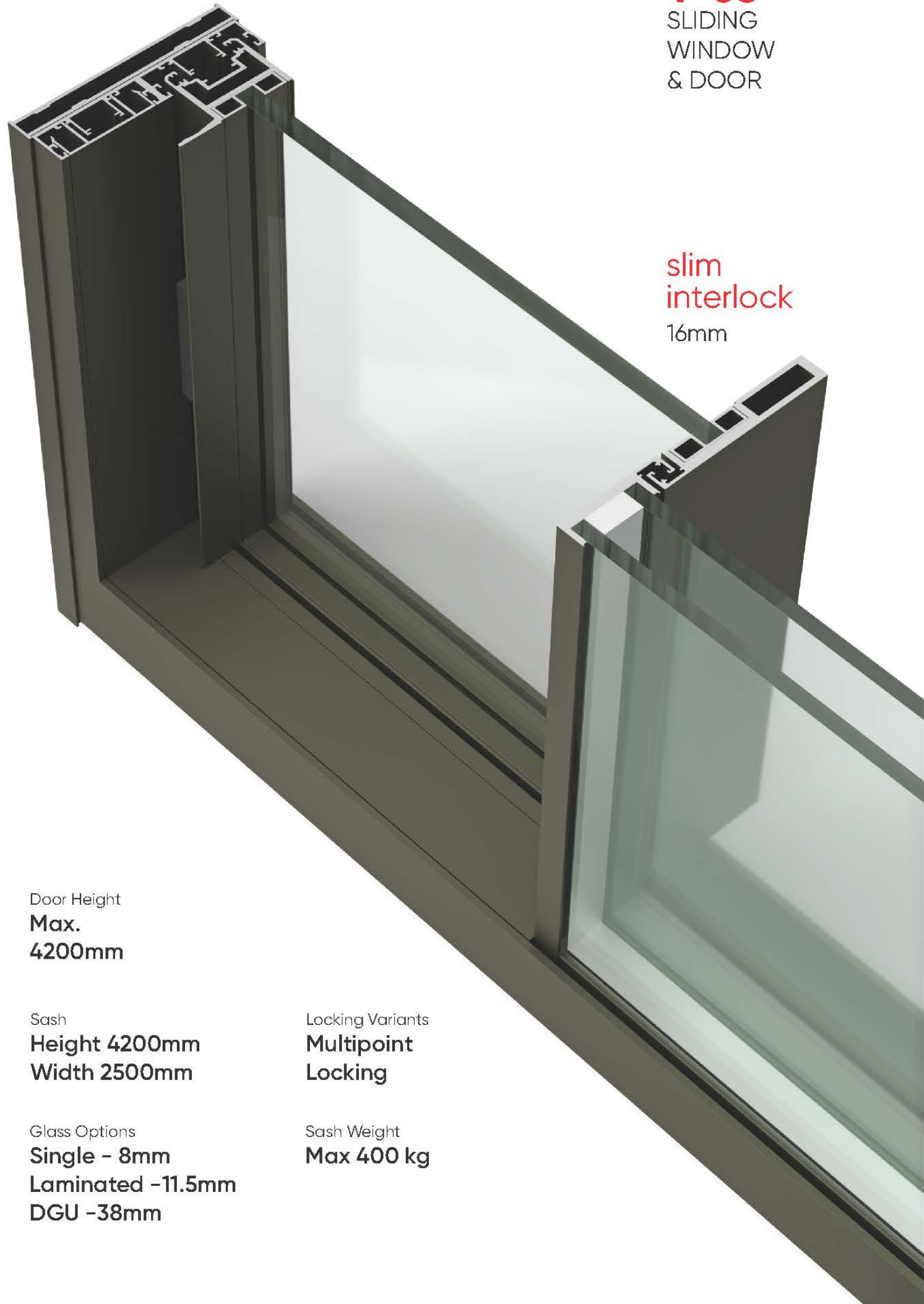

Door Height
Max.
4200mm

Sash
Height 4200mm
Width 2500mm

Glass Options
Single - 8mm
Laminated -11.5mm
DGU -38mm

Locking Variants
Multipoint
Locking

Sash Weight
Max 400 kg

vitco

 Sound
Insulation

 Wind
Load

 Air
Permeability

 Impact
Resistance

 Water
Tightness



typologies

2 Track

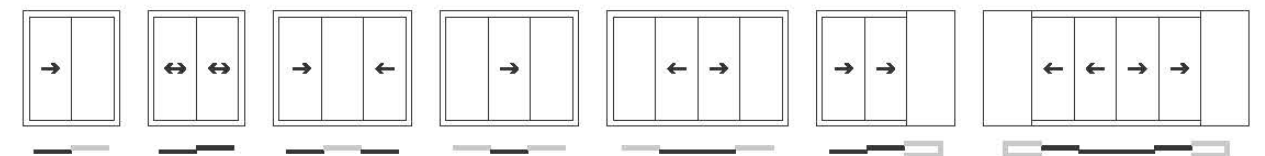

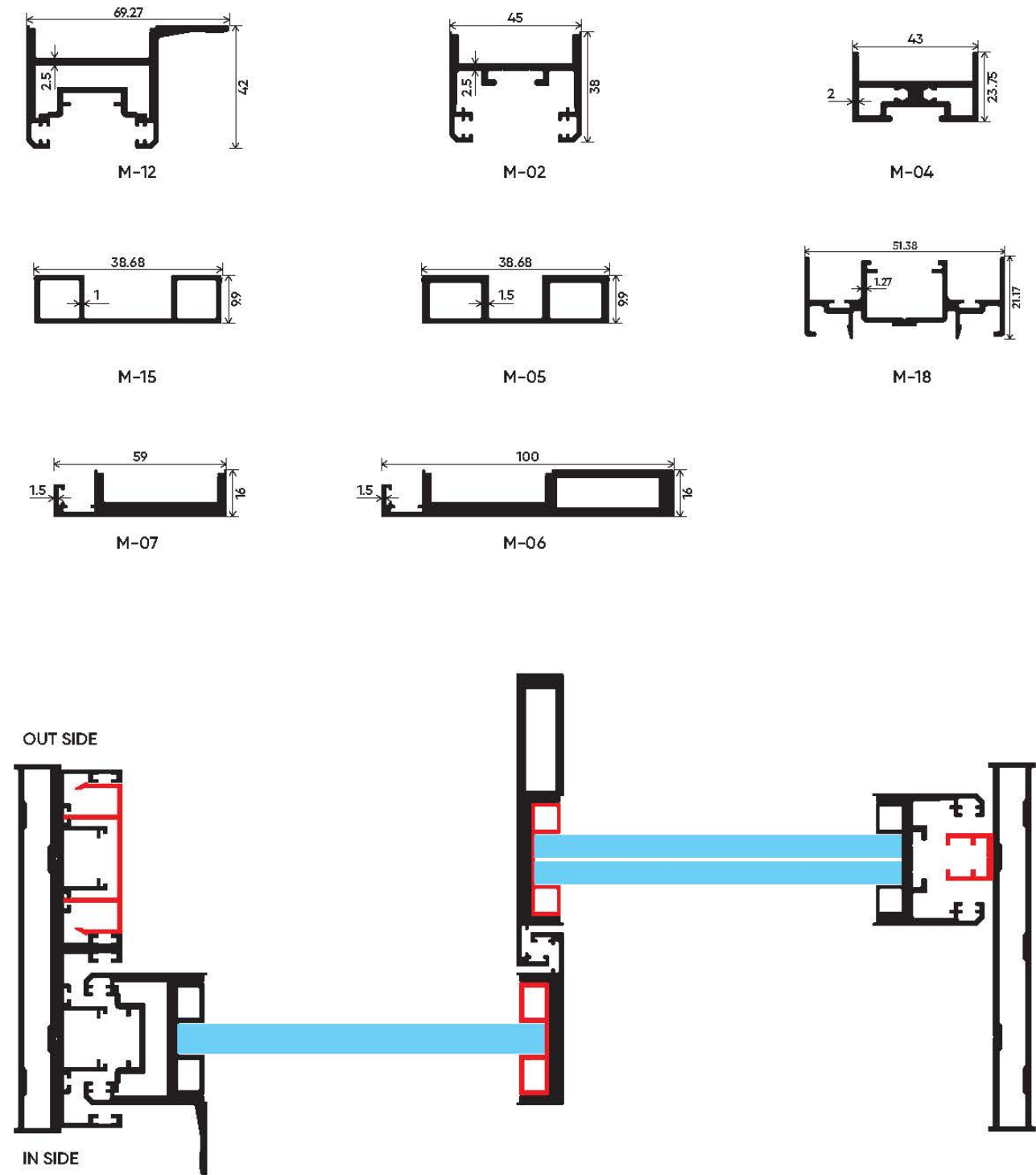
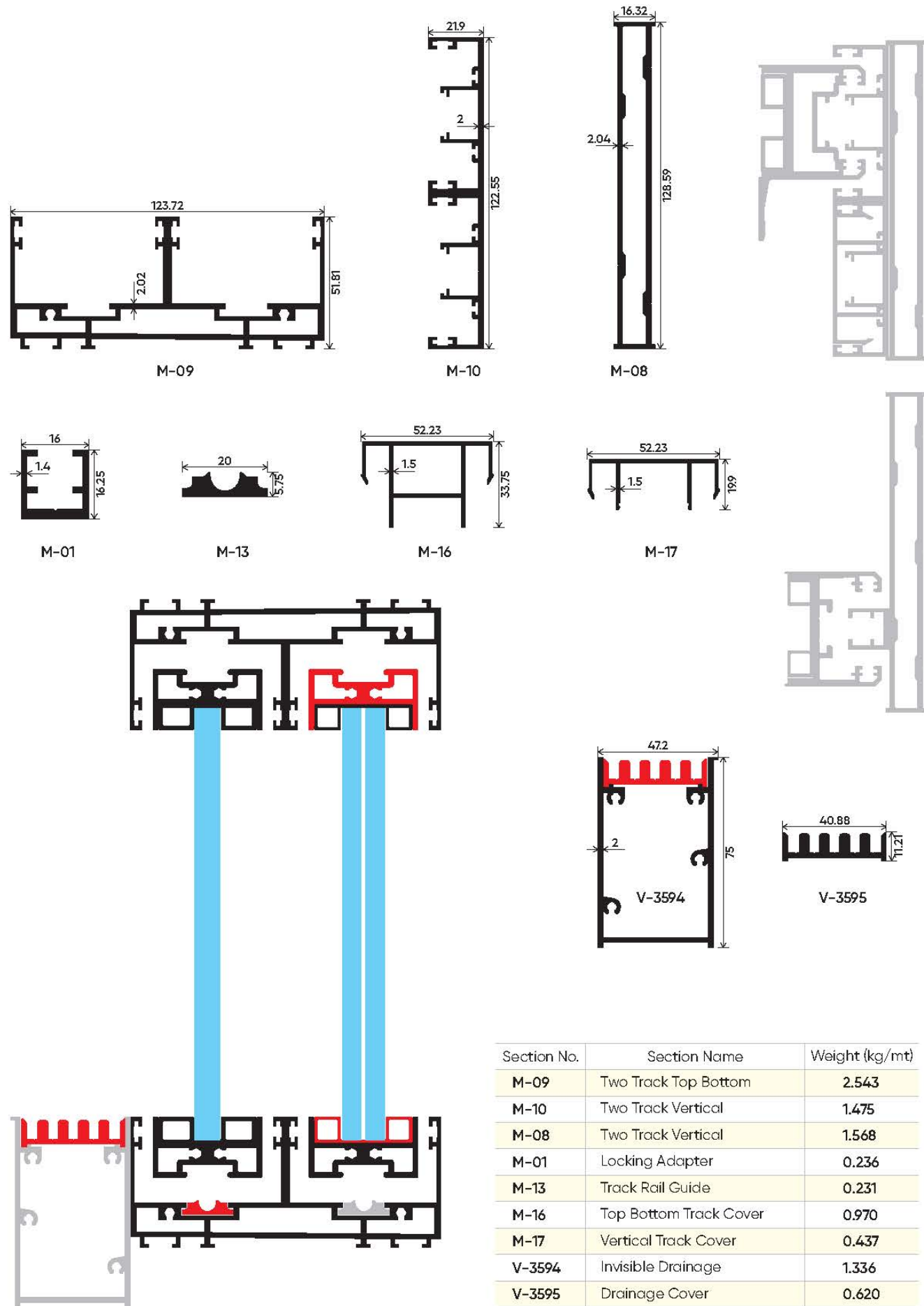

Section No.	Section Name	Weight (kg/mt)
M-12	Handle Profile Premium	1.415
M-02	Handle Profile	0.939
M-04	Top Bottom Profile	0.819
M-15	Laminated Reducer Clip	0.243

Section No.	Section Name	Weight (kg/mt)
M-05	SGU Reducer Clip	0.328
M-18	Center Opening	0.520
M-07	Slim Interlock	0.865
M-06	Reinforcement Interlock	1.735



40MM HIGH-END WINDOW & DOOR

minimal
system

Achieve architectural finesse with our premium minimal systems for windows and doors. Engineered with precision, they maintain structural integrity even at heights up to 14 feet. These systems blend innovation and style, offering effortless functionality. Transform your spaces into airy, luxurious retreats with this cutting-edge design.

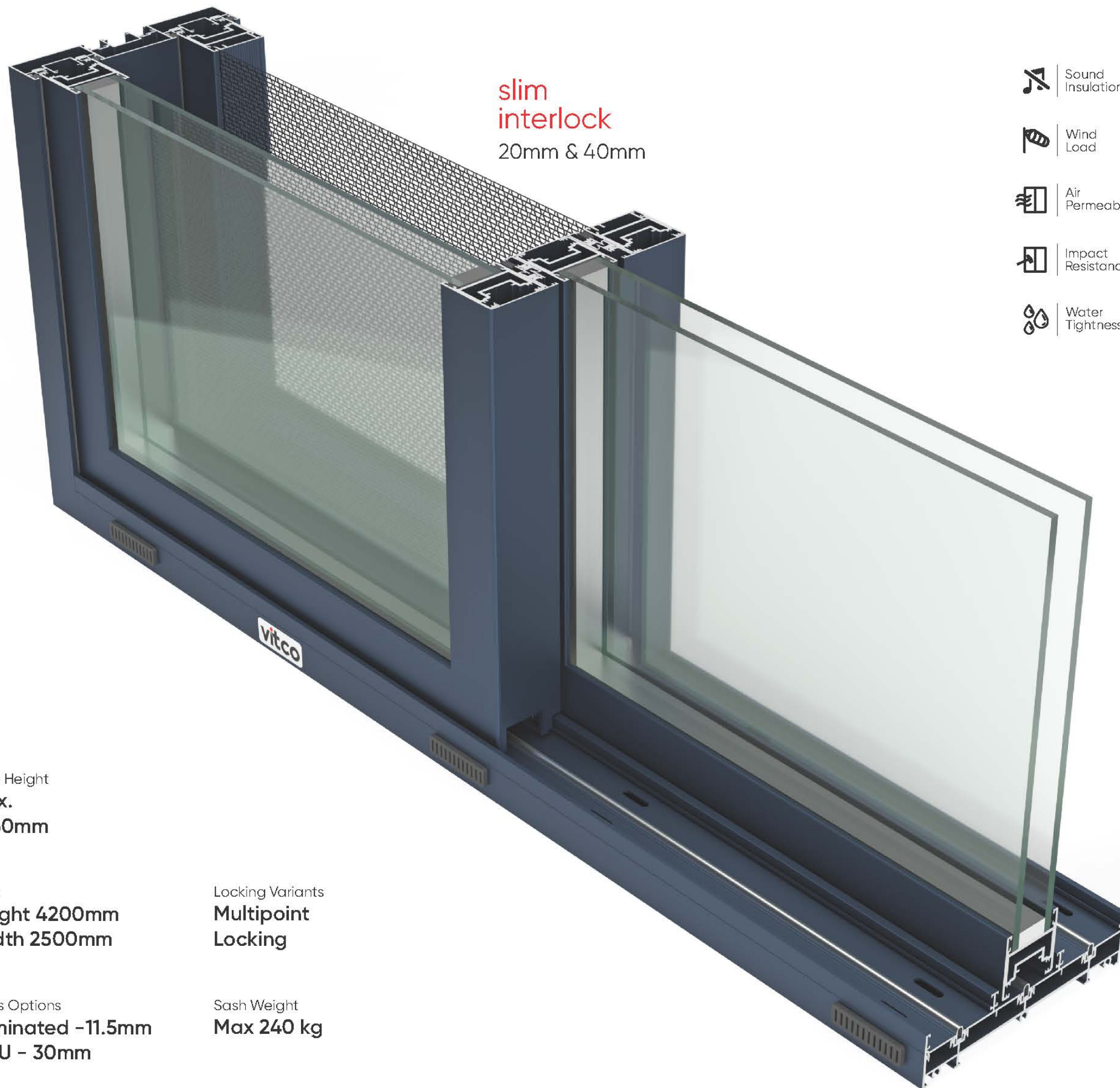

slim
interlock
20mm & 40mm

- Sound Insulation
- Wind Load
- Air Permeability
- Impact Resistance
- Water Tightness

Door Height
Max.
4250mm

Sash
Height 4200mm
Width 2500mm

Glass Options
Laminated -11.5mm
DGU - 30mm

Locking Variants
Multipoint
Locking

Sash Weight
Max 240 kg



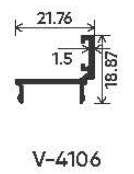
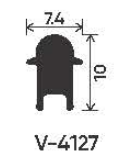
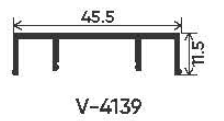
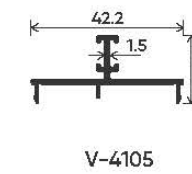
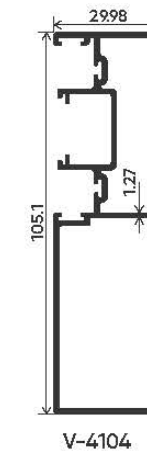
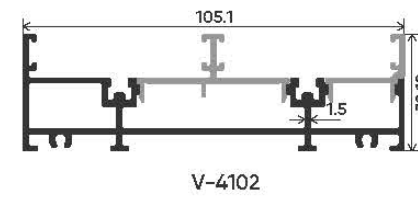
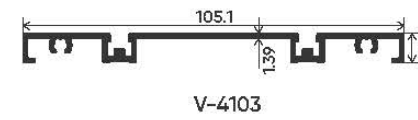
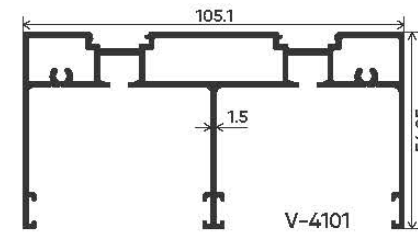
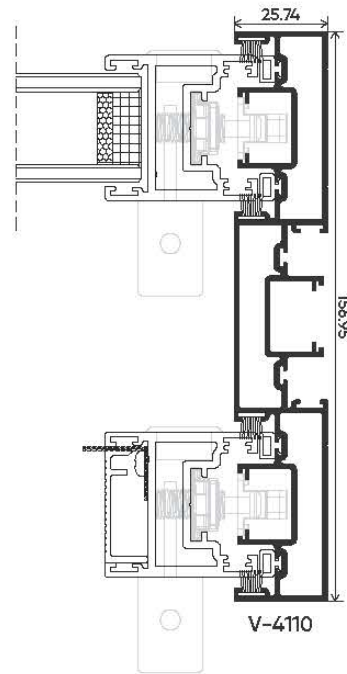
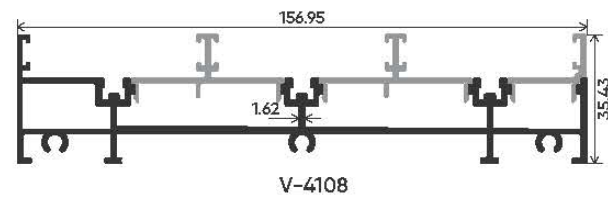
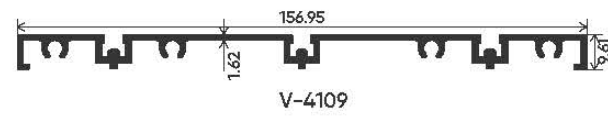
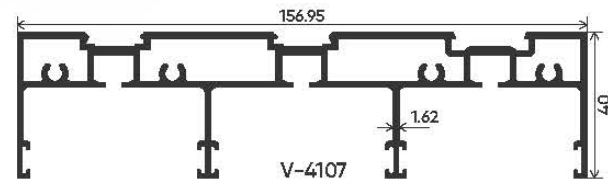
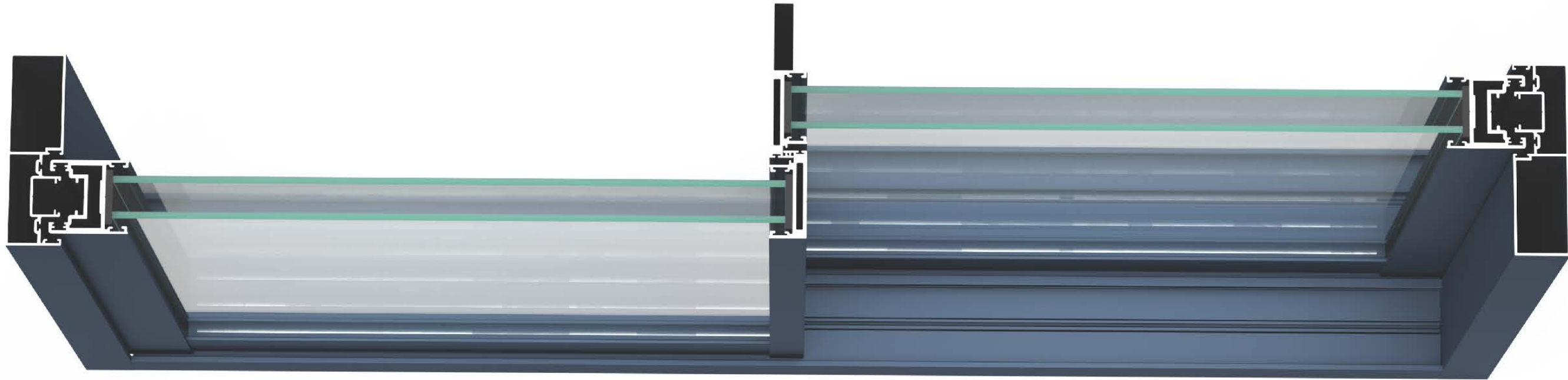

Section No.	Section Name	Weight (kg/mt)
V-4107	Three Track Top	2.470
V-4109	Three Track Bottom Threshold	1.300

Section No.	Section Name	Weight (kg/mt)
V-4108	Three Track Bottom	1.900
V-4110	Three Track Vertical Profile	2.150

Section No.	Section Name	Weight (kg/mt)
V-4101	Top Track	1.662
V-4103	Bottom Threshold	0.675
V-4102	Water Drainage Track	1.161
V-4104	Vertical Track	1.271

Section No.	Section Name	Weight (kg/mt)
V-4105	Bottom Track Cover	0.300
V-4139	Track Cover	0.300
V-4127	Bottom Track	0.200
V4106	Bottom Track Cover	0.177

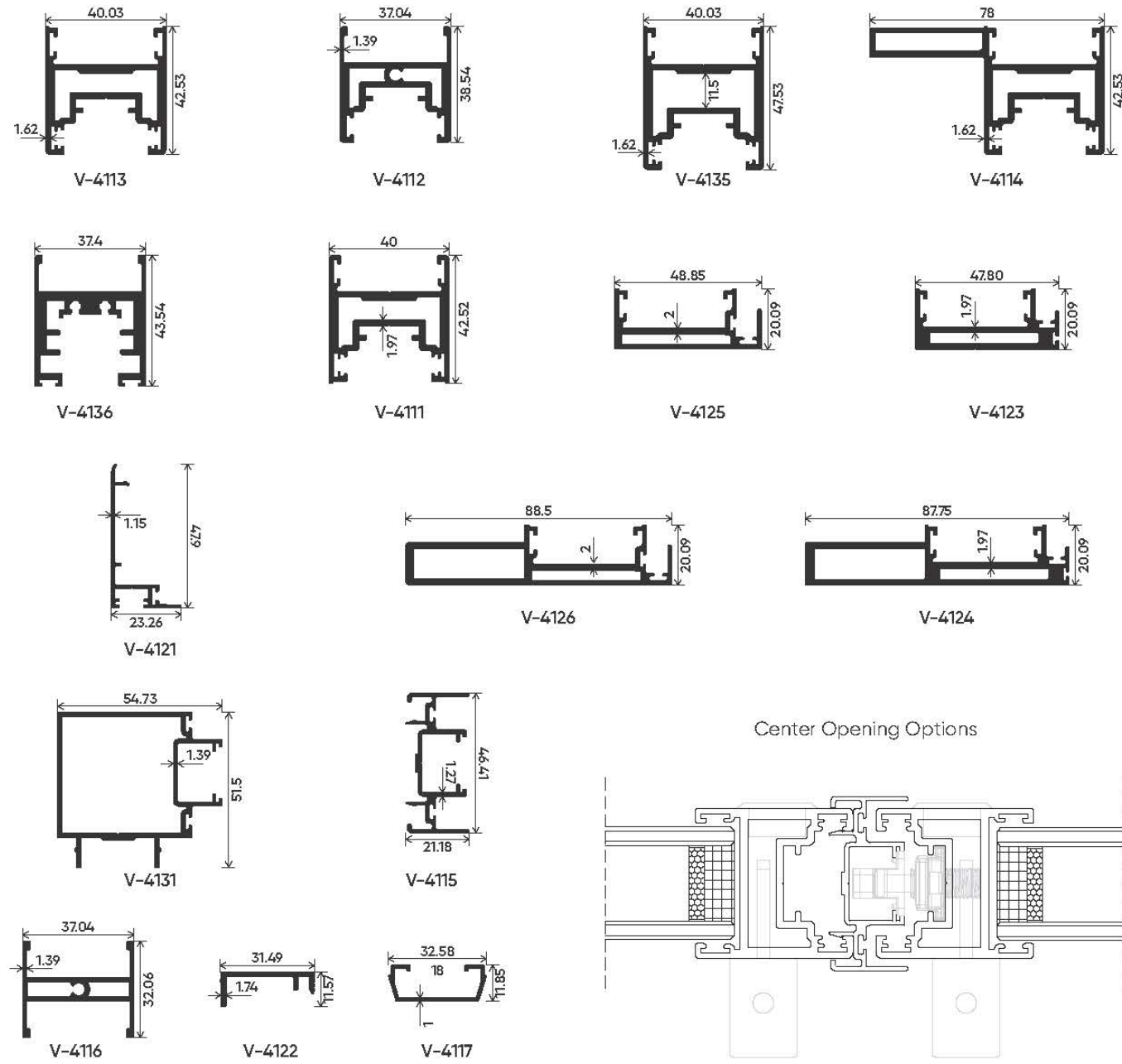

Section No.	Section Name	Weight (kg/mt)
V-4113	90° Cutting Shutter	1.155
V-4112	Top Bottom Shutter	0.944
V-4135	90° Cutting Shutter	1.202
V-4114	Box Reinforcement Shutter	1.586
V-4136	Top Bottom Shutter Heavy	1.224
V-4111	45° Cutting Shutter	1.150
V-4125	Slim Interlock	0.750
V-4123	Slim Interlock	0.787

Section No.	Section Name	Weight (kg/mt)
V-4121	Interlock Clip	0.286
V-4126	Box Reinforcement Interlock	1.295
V-4124	Box Reinforcement Interlock	1.302
V-4131	Corner Profile	0.875
V-4115	Glass Meeting Section	0.944
V-4116	Glass/Mess Middle Shutter	0.618
V-4122	Mosquito Clip	0.214
V-4117	Laminated Glass Clip	0.191

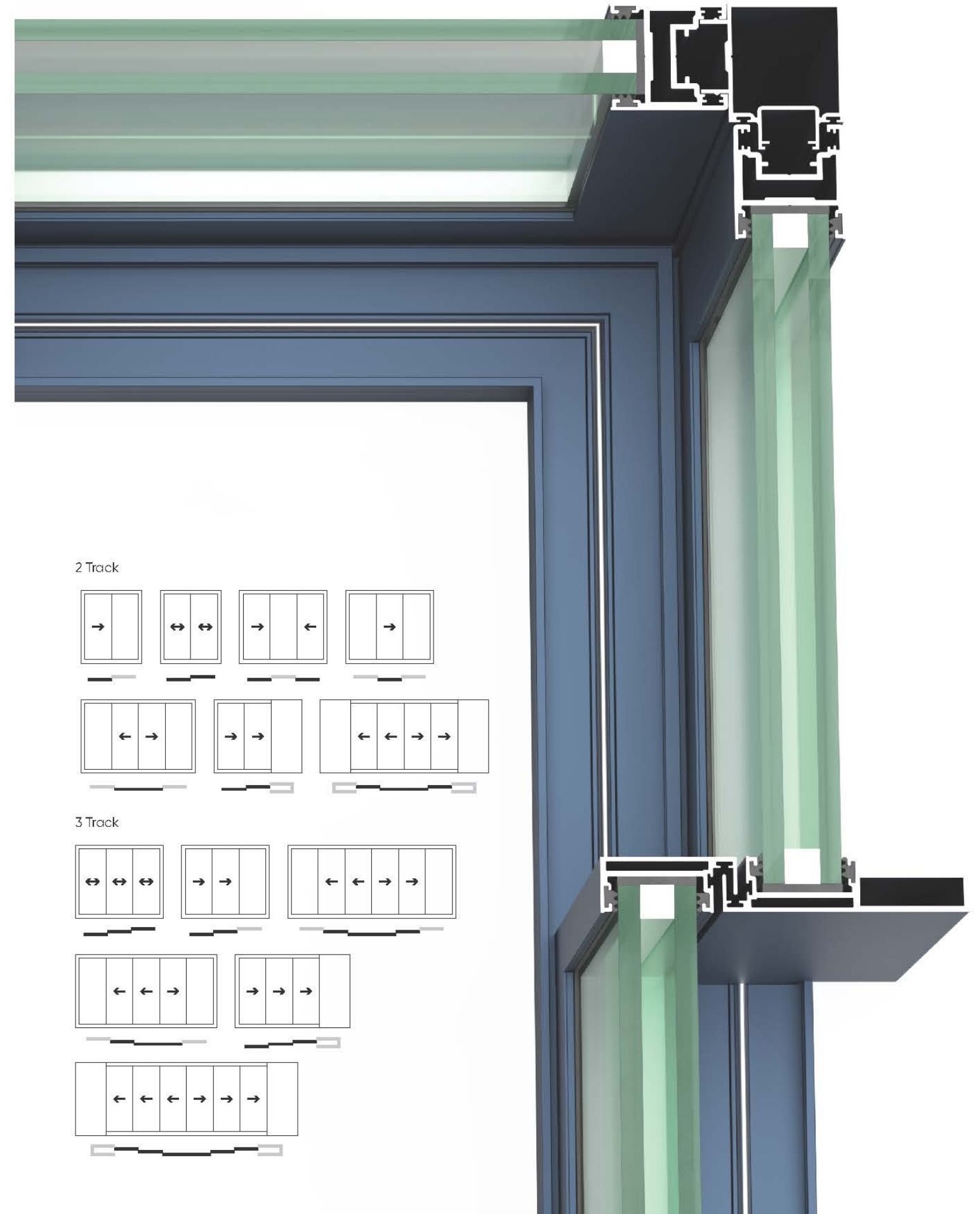



SC-85 CASEMENT WINDOW

minimal system

Our aluminum casement windows are a perfect blend of elegance and functionality. Built with precision and high-quality materials, they enhance ventilation and style in any room. Ideal for bedrooms, living areas, and kitchens, their durable frames ensure lasting performance. Add a touch of class with this timeless design.

SC-85
CASEMENT
WINDOW

41

42

Shutter Height
Max.
1200mm

Sash
Height 1200mm
Width 800mm

Glass Thickness
Min. 12mm
Max. 36mm

Glass Options
Single
DGU

 Sound
Insulation

 Wind
Load

 Air
Permeability

 Impact
Resistance

 Water
Tightness

vitco



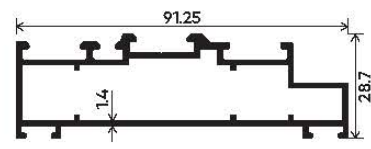

U-2

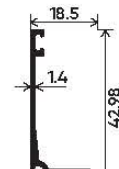

U-3

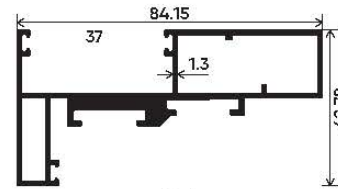

U-1

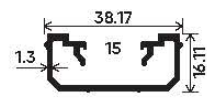

U-7

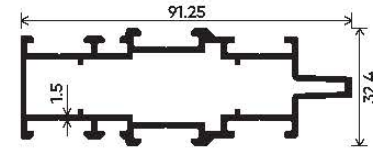

U-4

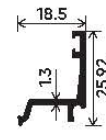

U-5

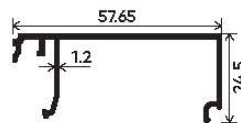

U-8

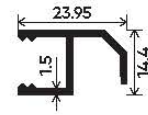

U-6

Section No.	Section Name	Weight (kg/mt)
U-2	Frame	1.157
U-3	Long Clip	0.251
U-1	Shutter	1.306
U-7	Glass Reducer Clip	0.346

Section No.	Section Name	Weight (kg/mt)
U-4	Mullion	1.311
U-5	Clip	0.196
U-8	Clip	0.437
U-6	Rain Cover	0.224

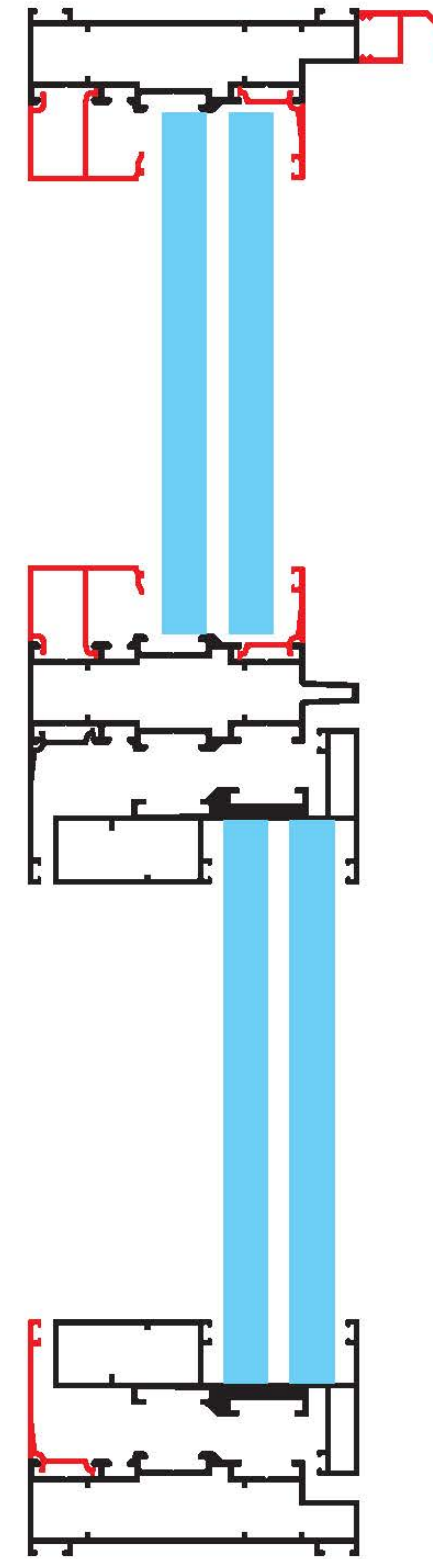

DGU Assembly

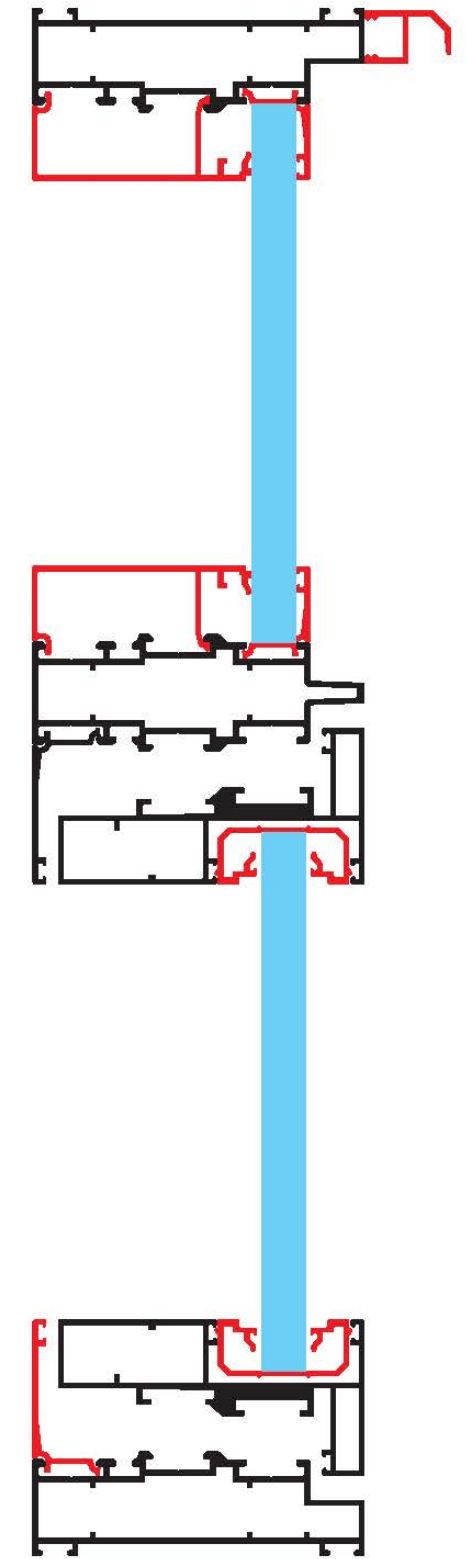

SGU Assembly





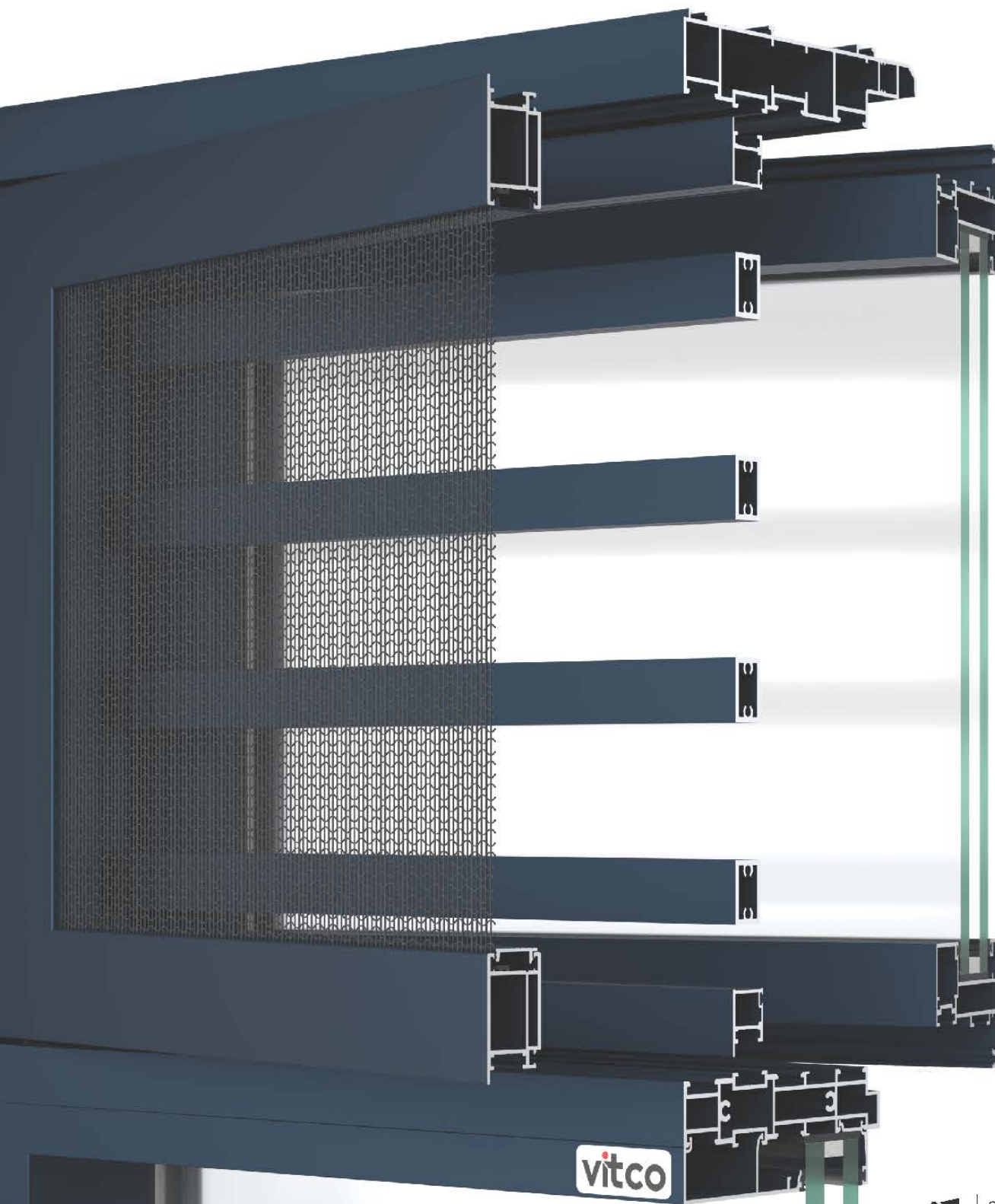

SC-3in1 CASEMENT WINDOW

minimal system

Designed for superior comfort and aesthetics, our casement windows are a versatile addition to any space. Their sturdy aluminum frames offer excellent insulation while providing easy operation. Whether in a cozy bedroom or a lively living room, they ensure style and practicality in equal measure.



SC-3in1
CASEMENT
WINDOW

-  Sound Insulation
-  Wind Load
-  Air Permeability
-  Impact Resistance
-  Water Tightness

Shutter Height
Max.
1200mm

Sash
Height 1200mm
Width 800mm

Glass Thickness
Min. 12mm
Max. 36mm

Glass Options
Single
DGU

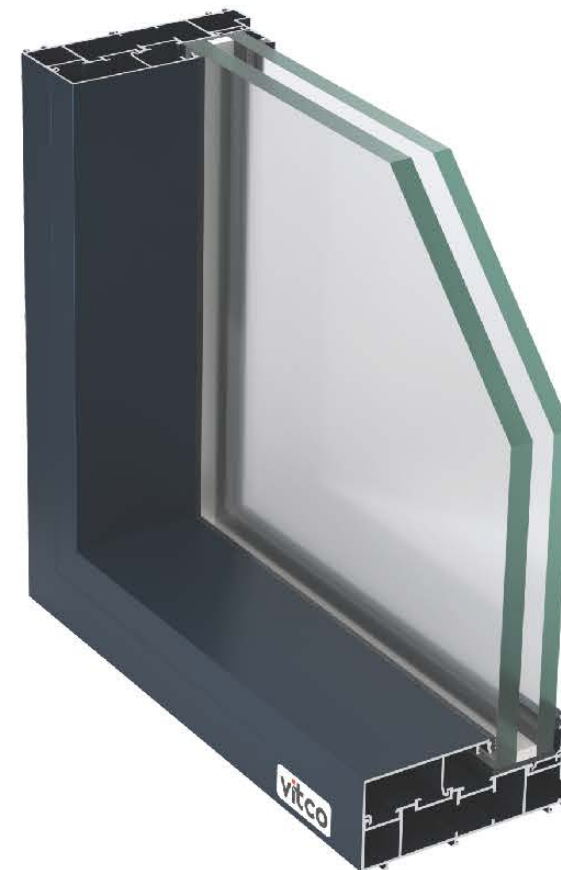

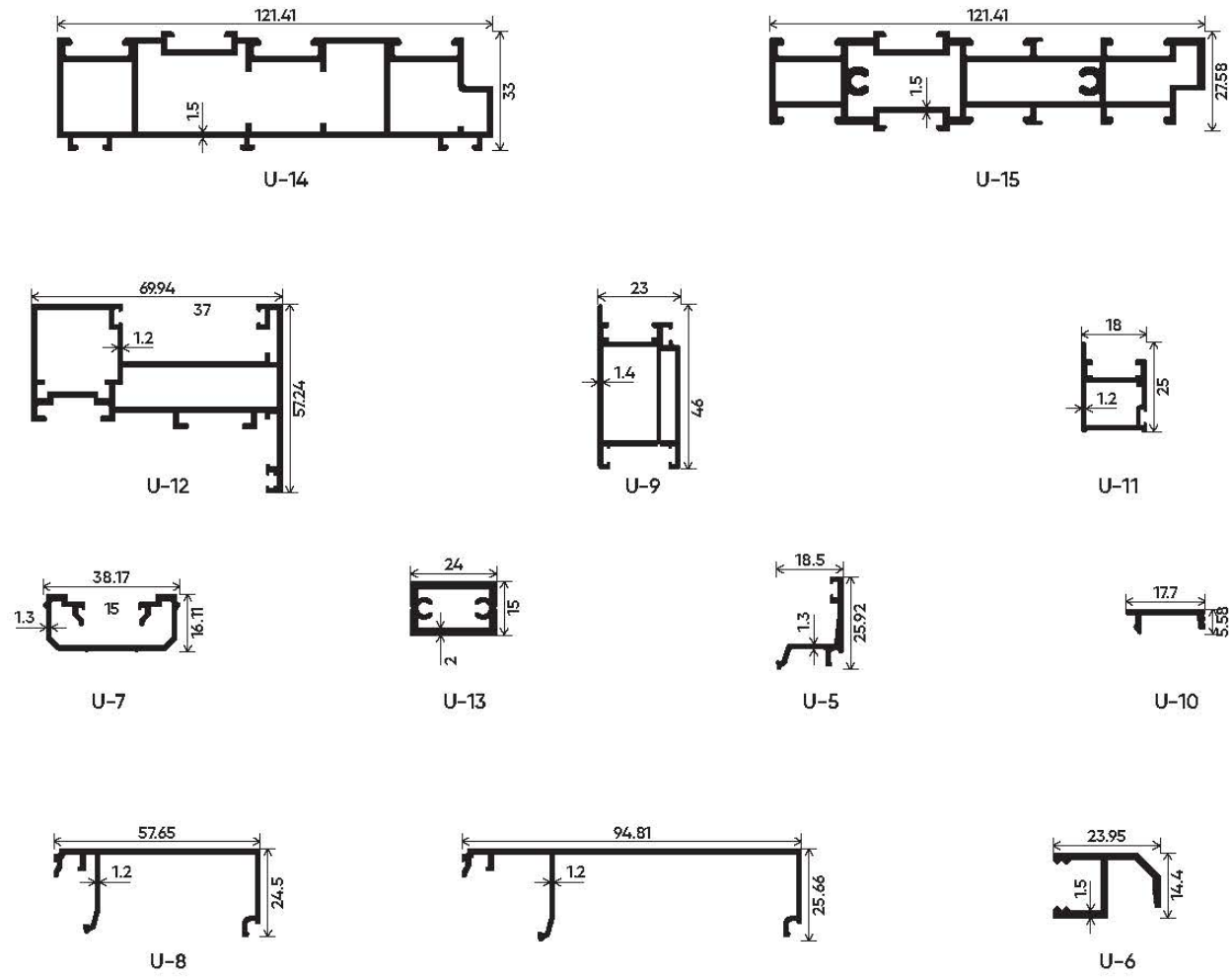

Section No.	Section Name	Weight (kg/mt)
U-14	Frame	1.848
U-15	Mullion	2.726
U-12	Shutter	1.093
U-9	Mosquito Shutter	0.577
U-11	Grill Shutter	0.273
U-7	Glass Reducer Clip	0.346

Section No.	Section Name	Weight (kg/mt)
U-13	Grill Pipe	0.432
U-5	Clip	0.196
U-10	Mosquito Cover	0.081
U-8	Clip	0.437
U-	Clip	0.595
U-6	Rain Cover	0.224

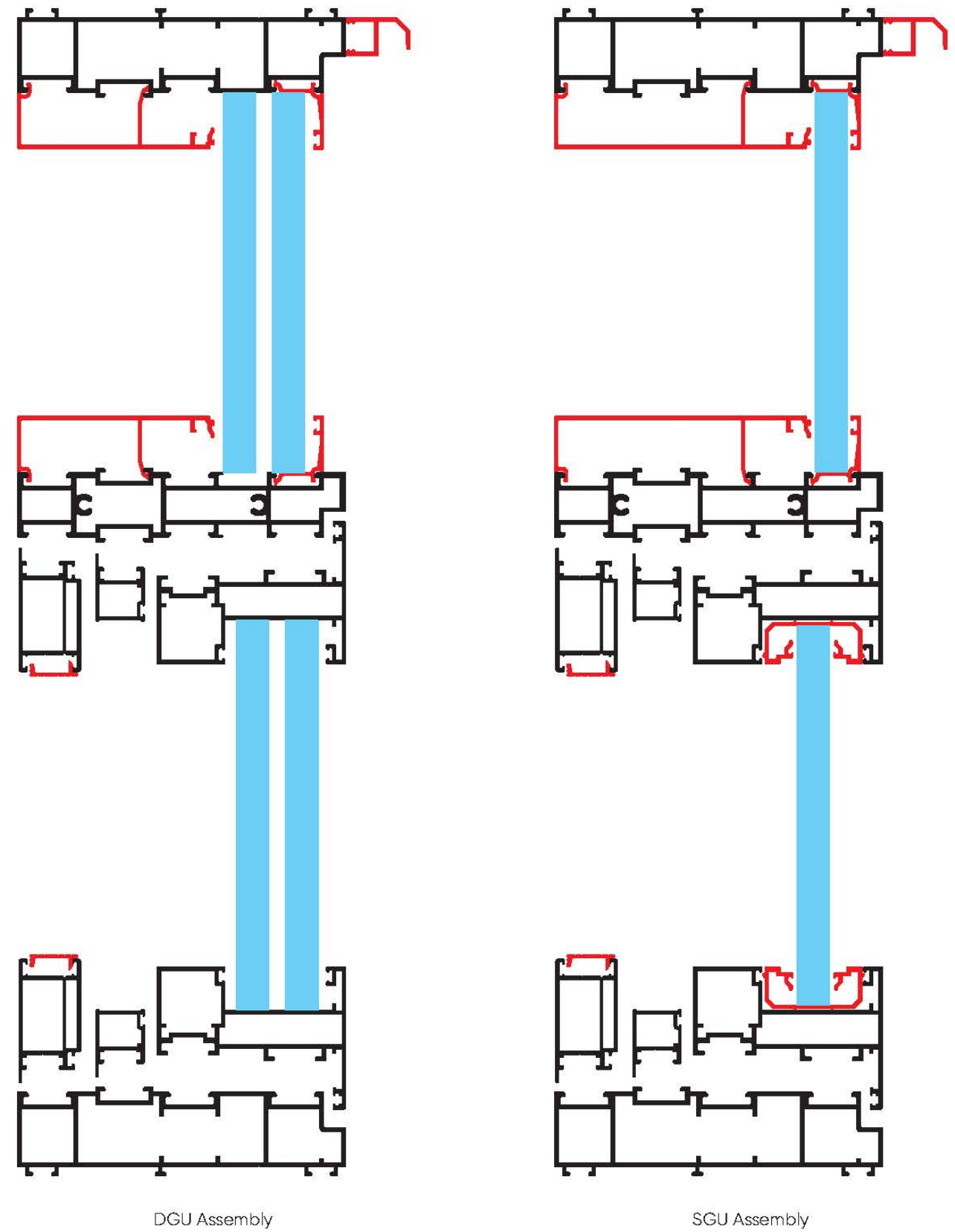

vitco 65MM THERMAL BREAK WINDOW

51

Profile Thickness
1.6mm
Size Range
900x2000mm
Max Load
90kg

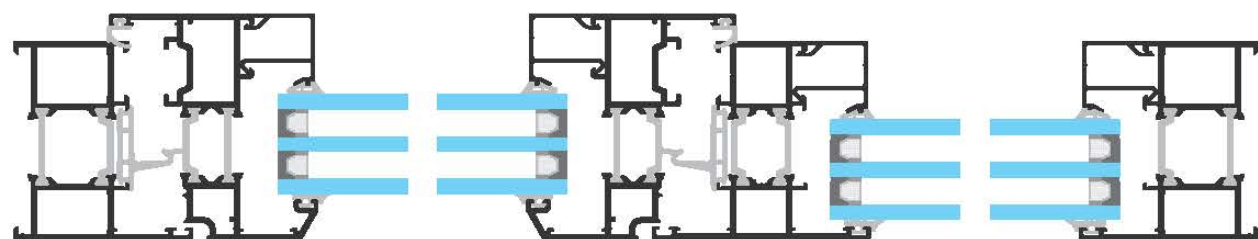
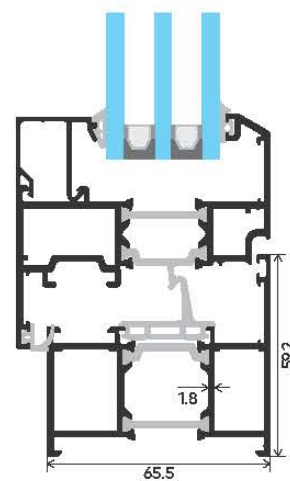
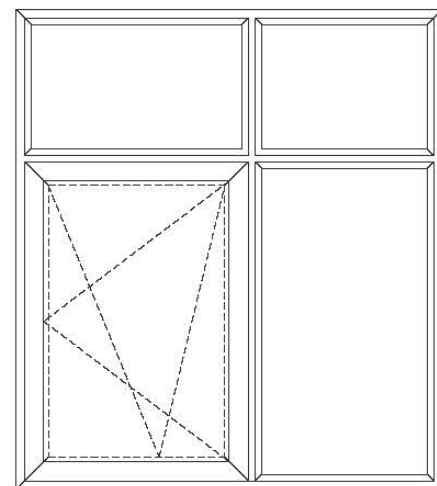

52

vitco 65MM THERMAL BREAK DOOR

Profile Thickness
1.6mm
Size Range
900x2000mm
Max Load
90kg

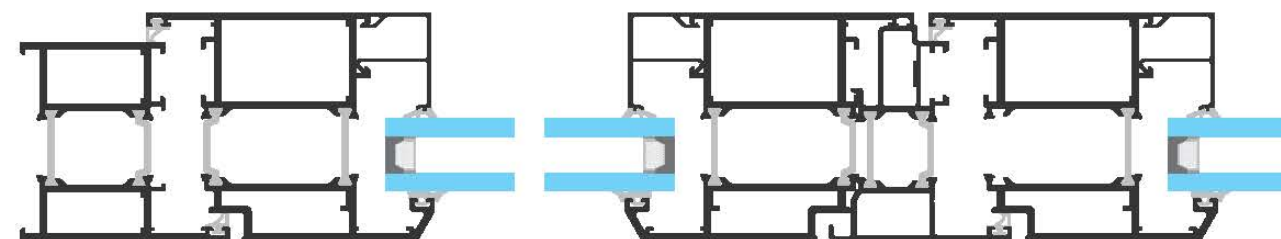
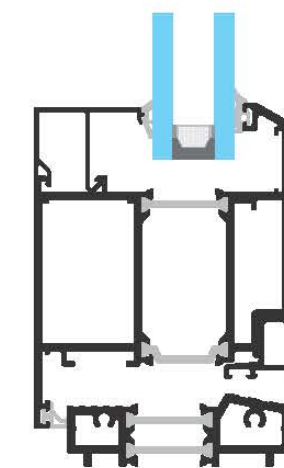
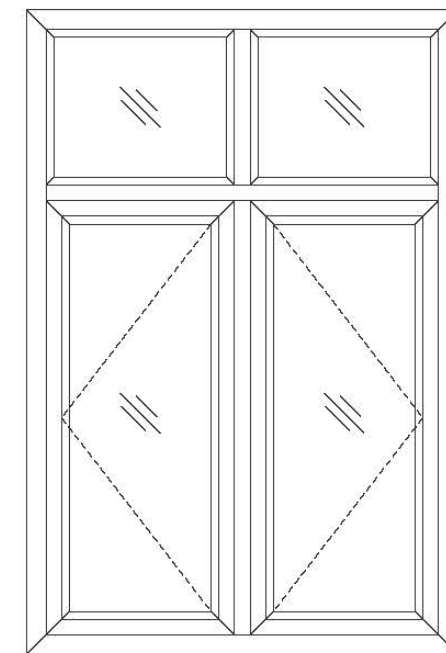

Profile Thickness
1.6mm
Size Range
900x2000mm
Max Load
90kg

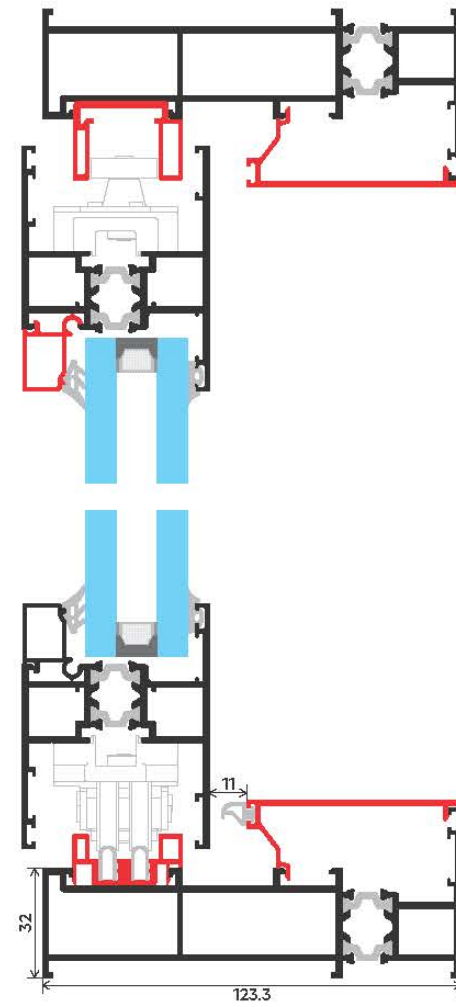
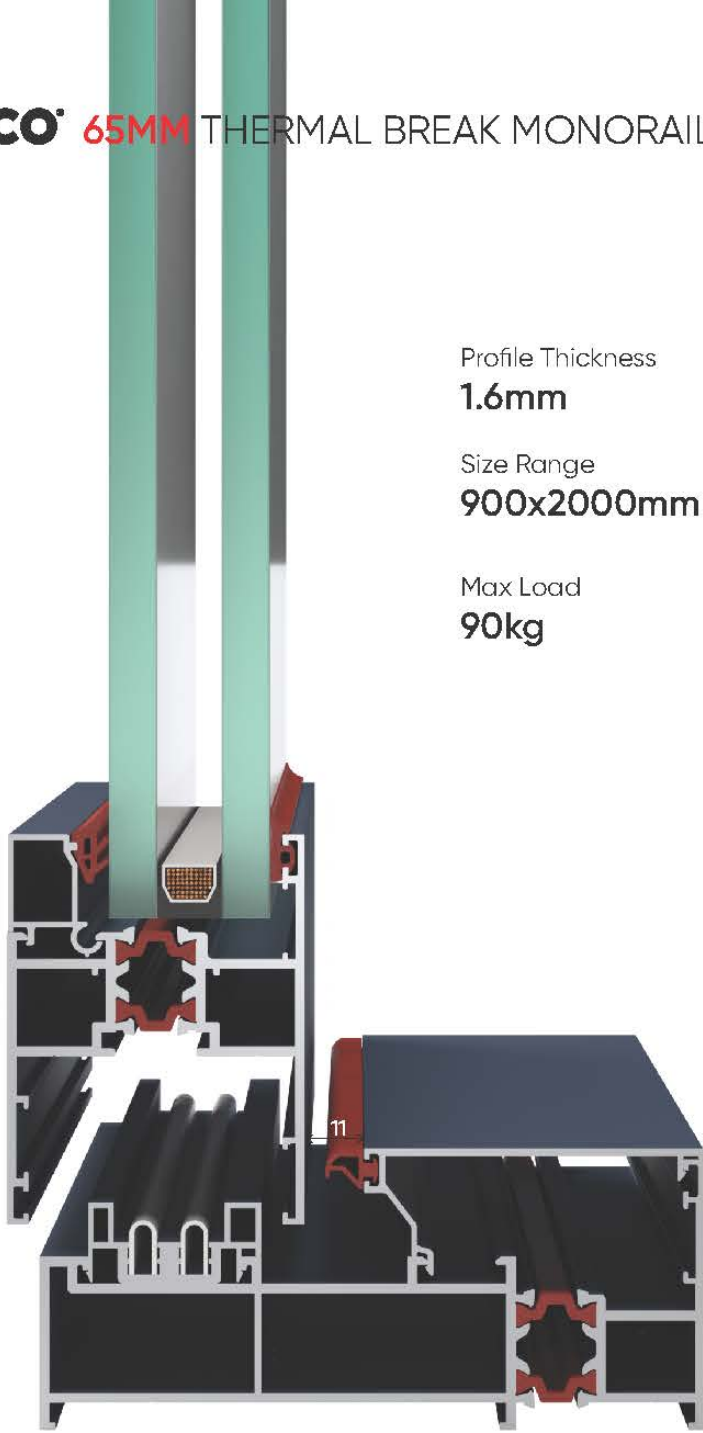

Sliding Position

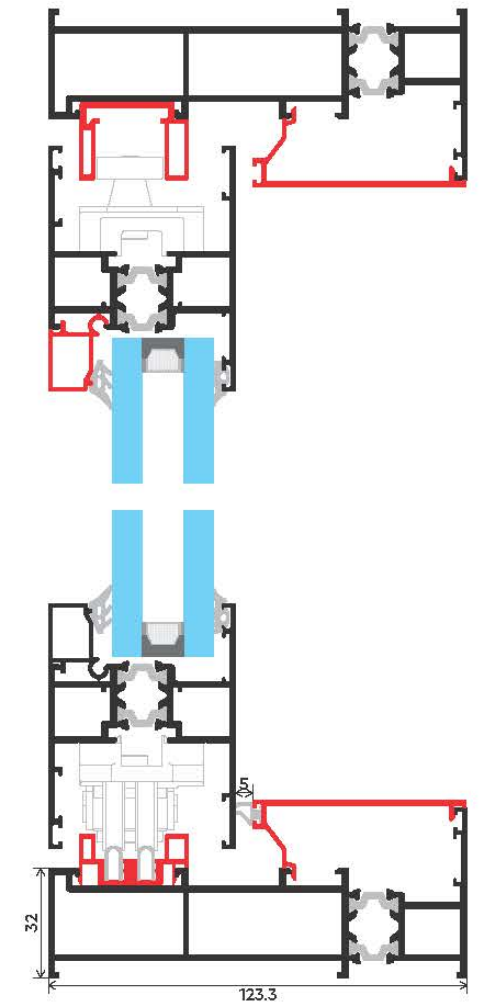
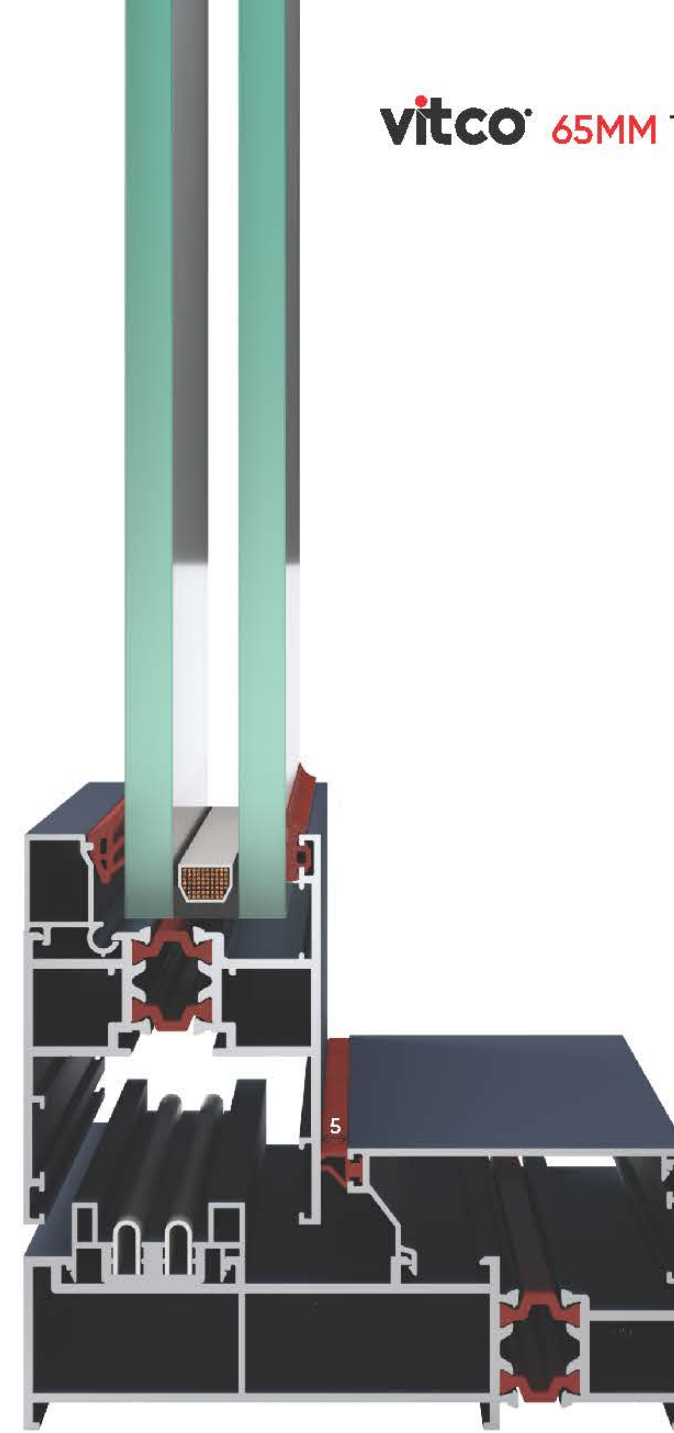

Locking Position

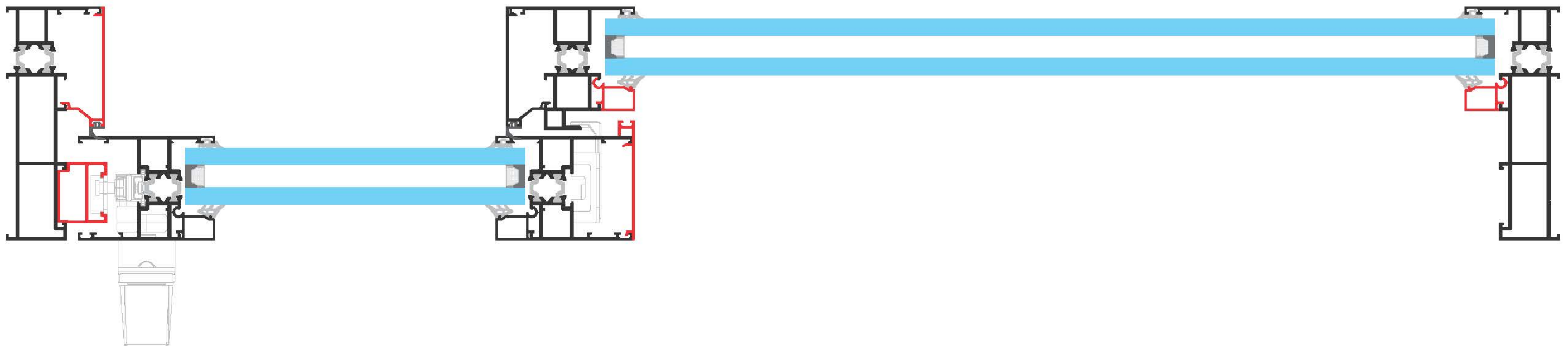

vitco[®] colour collection

From contemporary to heritage, the vitco colour collection combines four high-quality colour ranges. Anodizing and powder coating each offer a wide choice of durable coatings that are extremely resistant to scratching and corrosion.

With an inspired range of textured, non-textured and metallic finishes, these palettes have been designed to reflect increasingly popular colour trends within the market.

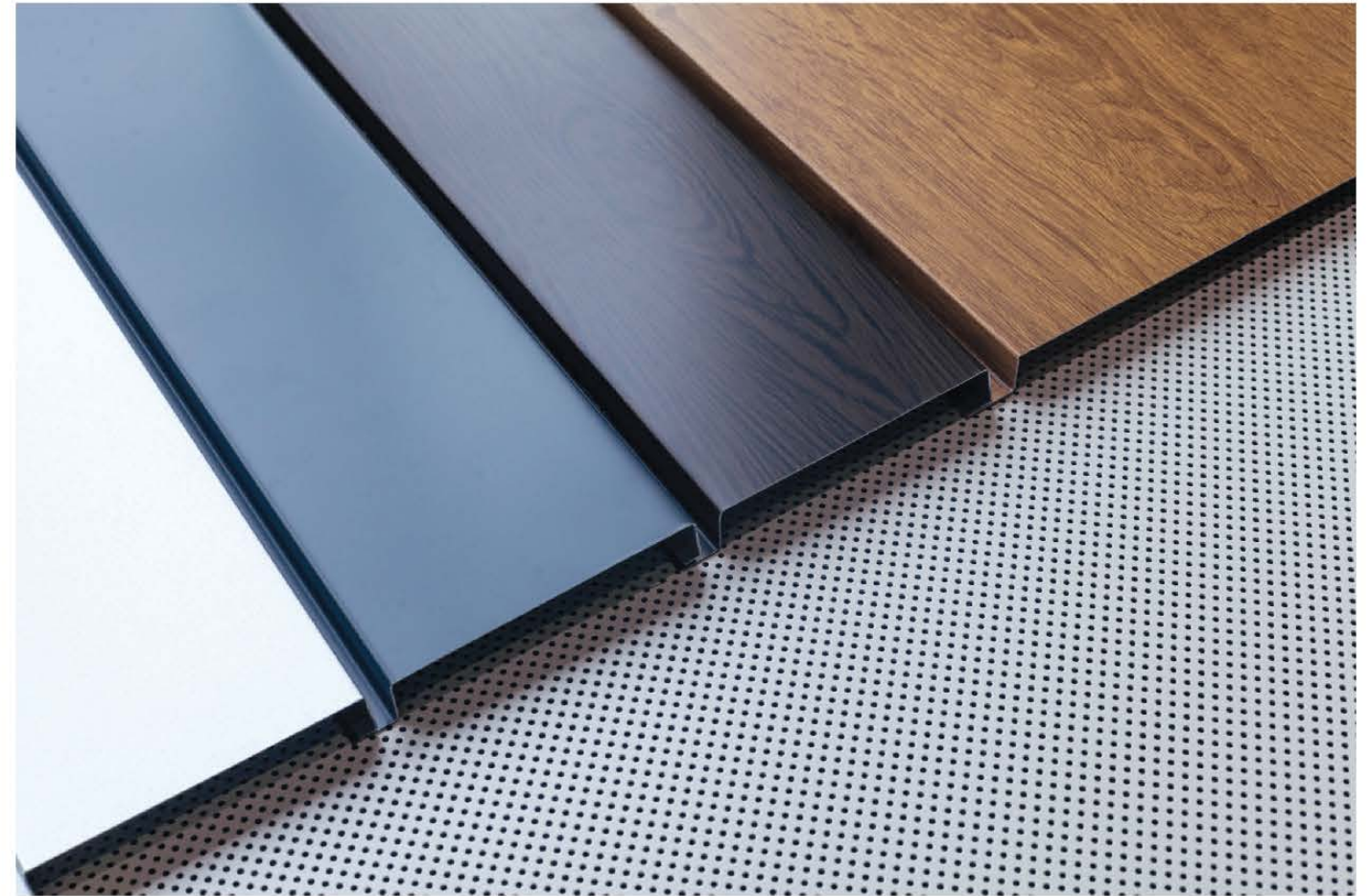

powder coating

Inspired by the diversity of nature, Elements offers the perfect combination of rich colours and versatile shades. With 18 RAL options to explore, you can enjoy a stylish, matt finish to your windows and doors.



Anodizing

Inspired by the intensity of contrast, Urbane offers the distinctive combination of robust tones and smooth shades that match the look and feel of an anodised finish. With 14 colours to choose from, you can enjoy a bold, protective finish to your windows and doors.



Alu-Rich

Experience Center/Office

202, 203, Rudram Icon,
Nr. Silver Oak Engineering College,
Opp. LAMBDA House, Gota,
Ahmedabad - 382481. Gujarat, India
M: +91 9726422426
E: info@vitco.co.in
W: www.vitco.co.in

Plant Address

Vinitech Metal Pvt Ltd
Survey No-289, 301, Chhatral-Pansar Road,
Ahmedabad-Mehsana Highway,
Village-Vadavswami,
Ta-Kalol, Dist-Gandhinagar,
Gujarat, India-382729
M: +91 99794 02701



Location

